

ESO

European Organisation
for Astronomical
Research in the
Southern Hemisphere

Annual Report 2012



ESO

European Organisation
for Astronomical
Research in the
Southern Hemisphere

Annual Report 2012

presented to the Council by the
Director General
Prof. Tim de Zeeuw

The European Southern Observatory

ESO, the European Southern Observatory, is the foremost intergovernmental astronomy organisation in Europe. It is supported by 15 countries: Austria, Belgium, Brazil¹, the Czech Republic, Denmark, France, Finland, Germany, Italy, the Netherlands, Portugal, Spain, Sweden, Switzerland and the United Kingdom. Several other countries have expressed an interest in membership.

Created in 1962, ESO carries out an ambitious programme focussed on the design, construction and operation of powerful ground-based observing facilities, enabling astronomers to make important scientific discoveries. ESO also plays a leading role in promoting and organising cooperation in astronomical research.

ESO operates three unique world-class observing sites in the Atacama Desert region of Chile: La Silla, Paranal and Chajnantor. ESO's first site is at La Silla, a mountain of height 2400 metres, 600 kilometres north of Santiago de Chile. It is equipped with several optical telescopes with mirror diameters of up to 3.6 metres.

The 3.5-metre New Technology Telescope (NTT) broke new ground for telescope engineering and design. It was the first in the world to have a computer-controlled main mirror, a technology developed at ESO and now applied to most of the world's current large telescopes. While La Silla remains at the



The ridge at La Silla.

forefront of astronomy, and is still the third most scientifically productive in ground-based astronomy (after Paranal and the Keck Observatory), the Paranal site, at 2600 metres above sea level, with the Very Large Telescope array (VLT), the Visible and Infrared Survey Telescope for Astronomy (VISTA), the world's largest survey telescope, and the VLT Survey Telescope (VST), the largest telescope designed to exclusively survey the skies in visible light, is the flagship facility of European astronomy. Paranal is situated about 130 kilometres south of Antofagasta in Chile, 12 kilometres inland from the Pacific coast in one of the driest areas in the world. Scientific operations began in 1999 and have resulted in many extremely successful research programmes.

The VLT is a most unusual telescope, based on the latest technology. It is not just one, but an array of four telescopes, each with a main mirror of 8.2 metres in diameter. With one such telescope, images of celestial objects as faint as magnitude 30 have been obtained in a one-hour exposure. This corresponds to seeing objects that are four billion times fainter than those seen with the naked eye.

One of the most exciting features of the VLT is the option to use it as a giant optical interferometer (VLT Interferometer or VLTI). This is done by combining the light from two or more of the 8.2-metre telescopes and including one or more of the four 1.8-metre movable Auxiliary



Panoramic view of the Chajnantor Plateau showing the site of the Atacama Large Millimeter/submillimeter Array, taken from near the peak of Cerro Chico.

¹ Brazil, having signed an Accession Agreement in December 2010, will officially become the 15th Member State of ESO on completion of the requisite ratification process.



A beautiful sunset from the top of Cerro Paranal, home of the Very Large Telescope.

Telescopes (AT). In this interferometric mode, the telescope has vision as sharp as that of a telescope the size of the separation between the most distant mirrors. For the VLTI, this is 200 metres.

Each year, about 2000 proposals are submitted for the use of ESO telescopes, requesting between three and six times more nights than are available. ESO is the most productive ground-based observatory in the world and its operation yields many peer-reviewed publications: in 2012 alone, more than 870 refereed papers based on ESO data were published.

The Atacama Large Millimeter/submillimeter Array (ALMA), the largest ground-based astronomy project in existence, is a revolutionary facility for world astronomy. ALMA comprises an array of 66 12- and 7-metre diameter antennas observing at millimetre and submillimetre wavelengths. ALMA was inaugurated in 2012 and is located on the high-altitude Chajnantor Plateau, at 5000 metres above sea level — one of the highest astronomical observatories in the world. The ALMA project is a partnership between Europe, East Asia and North America, in cooperation with the Republic of Chile. ESO is the European partner in ALMA.

The Chajnantor site is also home to the Atacama Pathfinder Experiment (APEX) a 12-metre millimetre and submillimetre telescope, operated by ESO on behalf of the Max Planck Institute for Radio Astronomy, the Onsala Space Observatory and ESO itself.

The next step beyond the VLT is to build a European Extremely Large optical/infrared Telescope (E-ELT) with a primary mirror 39.3 metres in diameter. The E-ELT will be the “world’s biggest eye on the sky” — the largest optical/near-infrared telescope in the world. The E-ELT will address many of the most pressing unsolved questions in astronomy. It may, eventually, revolutionise our perception of the Universe, much as Galileo’s telescope did 400 years ago. The final go-ahead for construction is expected in 2013, with the start of operations at the beginning of next decade.

ESO’s headquarters are located in Garching, near Munich, Germany. This is the scientific, technical and administrative centre of ESO where technical development programmes are carried out to pro-

vide the observatories with the most advanced instruments. ESO’s offices in Chile are located in Vitacura, Santiago. They host the local administration and support groups, and are home to ESO/Chile astronomers when they are not at the observatories. This site also contains the new ALMA Santiago Central Office. ESO Vitacura has become an active node for training new generations of researchers, acting as a bridge between scientists in Europe and Chile.

The regular Member State contributions to ESO in 2012 were approximately 133 million euros and ESO employs 717 staff members.

Artist’s impression of the European Extremely Large Telescope in its enclosure on Cerro Armazones.



ESO/L. Calçada

Contents

The European Southern Observatory	2
Foreword	6
Introduction	7
Science	10
Research Highlights	11
Offices for Science	22
Allocation of Telescope Time	26
Publication Digest	30
Operations	32
La Silla Paranal Observatory	33
Data Management and Operations Division	40
European ALMA Support Centre	44
Programmes	46
Instrumentation for the La Silla Paranal Observatory	47
ALMA	54
European Extremely Large Telescope	64
Engineering	66
Technology Division	67
Software Development	72
Administration	76
Finance and Budget	78
Human Resources	80
List of Staff	84
Organigram	89
Office of the Director General	90
Legal Service	91
Chile Relations	92
International Relations	94
Committees	98
Council	99
Finance Committee	101
Scientific Technical Committee	102
Observing Programmes Committee	104
ALMA Proposal Review Committee	106
Users Committee	107
Outreach	110
Calendar of Events	116
Glossary of Acronyms	118

Foreword

Pride, success and big challenges characterised the year 2012 at ESO. Achieving 50 years of cooperation in astronomy and building and operating some of the most productive ground-based telescopes in the world is a good reason for pride for all members of the big ESO family — staff, astronomers, institutes, industries and governments and also Council. Celebration activities took place all across the Member States, raising society's awareness of ESO's remit and success. In particular I should like to thank the Ministers and high-level dignitaries, colleagues and friends who joined us at the celebration in Munich on 11 October. This year also provided an opportunity for a retrospective appreciation of the impressive scientific and technological progress that ESO has enabled during its half century of history. Astronomy, the scientific discipline that aims at knowing and understanding the Universe, would not be the same today without ESO. This coming year, 2013, will see the celebration of another 50th anniversary — that of the first site agreement with the Republic of Chile, which marked the start of a long and fruitful collaboration.

The fact that La Silla–Paranal continued, for another year, to be one of the most successful scientific infrastructures in the world should not prevent us from realising and celebrating this very fact. Keeping the observatories up and running with the highest efficiency and with state-of-the-art instrumentation is something that does not normally make it to the front page of the newspapers, but it is what ultimately makes an international scientific organisation a success story. A key ingredient in this success is the very competent, engaged and dedicated staff who work at ESO.

Enormous progress was achieved with ALMA during the year. The number of accepted antennas increased dramatically to 51, while the remainder are already in Chile for integration. Some of the technologically more advanced items (front ends, back ends) are essentially finished; the ESO-delivered permanent power supply system is already energising ALMA's Operations Support Facility near San Pedro de Atacama and

the technical building, located at 5000 metres above sea level; the location of the ALMA Residencia has been decided and the architectural design is nearing completion. Everything is ready for a worldwide celebration in March 2013 when the President of the Republic of Chile, Sebastián Piñera, will inaugurate the observatory together with authorities from ESO Member States and the other ALMA partner regions. As expected, stunning scientific output from ALMA started appearing during the year. The first scientific papers have been published, with the majority of them involving astronomers from the ESO region. Even in its early configuration, ALMA is providing amazing astronomical data and scientific breakthroughs, whilst giving just a glimpse of the progress that will be achieved in the years to come when the array is complete.

This year, Council passed a major milestone towards the next big ESO project, the European Extremely Large Telescope, by approving the creation of the E-ELT programme. This required the positive vote, and associated financial commitment, of two thirds of the Member States. This was reached provisionally in June and fully in December. The Member States that paved the way to this important achievement at the time of the December Council meeting — Austria, Belgium, the Czech Republic, Finland, France, Germany, Italy, the Netherlands, Sweden, Switzerland and the United Kingdom, the latter with a provisional positive vote — will hopefully soon be joined by Denmark, Portugal and Spain. The ESO Council has been unanimous in showing interest in, and support for, the project, with the difference in the timing of joining the programme being, hopefully, a short-term interim situation. The goal is that the E-ELT, like ALMA and the VLT, will soon become part of ESO's core programme, fully shared by all Member States.

Construction of the E-ELT in full needs not only the commitment of the current Member States, which are pledging additional funds for this project, but also the ratification by Brazil of its accession to the organisation as its 15th Member State. The E-ELT project is technically

ready to start construction, a situation that has driven the participating ESO Member States to sign up for the programme. Ways to bring forward the start of the construction are being explored by ESO management and Council.

I should like to dedicate a few lines to highlight something obvious but important, namely that ESO is part of the research and development system of its Member States. ESO provides opportunities to these Member States in the terms of science, technology, industrial activities, employment and cooperation. At the same time, ESO is funded by the governments of the same Member States in line with the Convention and associated protocols. While the overall financial environment is being impacted by national budget realities, it needs to be recognised and appreciated that the governments of the ESO Member States are doing their best to guarantee their participation in ESO's programme. The challenge ahead for Council is to maintain and further strengthen this support in view of the very challenging programme that we have collectively defined and to continue making ESO a success story, thus helping our Member States evolve towards a knowledge-based society.

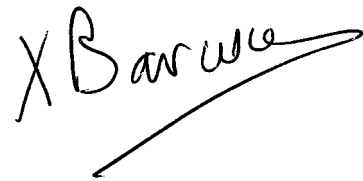

President of the ESO Council
Xavier Barcons

Introduction

This year was special for many reasons, not only because it marked ESO's 50th anniversary, but also because of the major progress achieved in a number of areas.

Belgium, France, Germany, Sweden and the Netherlands created ESO in 1962, with the dual aims of providing astronomers with a large telescope with which to study the southern night sky and of fostering collaborations in astronomy. A year later, ESO selected Chile as the Host State for its planned observatory, and subsequently achieved its initial objective with the construction of the La Silla Observatory, with its flagship 3.6-metre telescope starting operations in 1976. In the past half century, ESO's programme has expanded far beyond the original goal through the construction of the world-leading ground-based observatory on Paranal — hosting the VLT, the VLT Interferometer, VISTA and the VST; participation in the APEX partnership operating a 12-metre submillimetre antenna on Chajnantor; participation in the intercontinental partnership that has now nearly completed the construction of the world's largest radio telescope, ALMA, on Chajnantor; and the planned construction of the 39.3-metre diameter E-ELT on Armazones, with a projected start of operations early in the next decade. The number of Member States stands at 14, with Brazil poised to join as the first non-European Member State, and other countries expressing interest in joining in the near future.

The 50th anniversary celebrations included a special all-hands overview in March, a staff party in Garching in September, attended by the Council President, and a Gala Dinner on 11 October that clearly increased ESO's profile at the highest government levels in the Member States and in Chile. There were many activities in the Member States and the books *Europe to the Stars* by Govert Schilling and Lars Lindberg Christensen and *The Jewel on the Mountaintop* by Claus Madsen, which were specially commissioned for ESO's 50th anniversary, were published and well received. The number of high-level visits to the observatories also increased, including the early June summit — taking place on Paranal — of

the newly created Pacific Alliance, attended by the Presidents of Chile, Colombia, Mexico and Peru (with a brief appearance by the King of Spain), as well as a visit by Minister Schavan of ESO's Host State Germany in late September.

The ratification of the Brazilian Accession Agreement started making further progress when the responsible ministries submitted the ESO file to the Casa Civil on 30 May. The governments of many Member States and of Chile continued to encourage the Brazilian government to move forward and this led to the further critical decision taken by President Dilma Rousseff in early 2013 to send the ESO file for ratification to the Brazilian National Congress and the Federal Senate.

Another major milestone was the formal approval of the E-ELT as a supplementary programme as defined in the Convention. Provisional approval in June (with six Member States in favour, four in favour *ad referendum* and four abstentions) was followed by confirmation in December, when the required two-thirds majority of ten was reached. At the time of writing, 13 of the 14 Member States have joined the programme, and the remaining one is expected to join in the near future. As progress is made towards ratification in Brazil, the project is moving ahead, with the first calls for tenders being made, following successful and informative industry days in various Member States and at ESO Headquarters.

ALMA construction is on track for completion in 2013 and, by the end of the year 2012, most of the ESO deliverables were complete. Seventeen AEM antennas were accepted, with 15 in the array at the Array Operations Site (AOS) and the remainder in the verification phase or in mechanical integration at the Operations Support Facility (OSF). The permanent power supply was commissioned and the location of the Residencia was agreed. The Early Science observations, with a limited number of antennas, have already provided stunning demonstrations of the tremendous power of the array, and included the discovery of interstellar building blocks of amino acids, the structure of planet-forming discs, detailed mapping of mass loss from evolved stars,



and the detection of molecular gas in galaxies at redshifts of almost six. The response to the Cycle 1 call for proposals was even larger than in the previous year (Cycle 0).

The second generation VLT instrument KMOS achieved first light and the replacement laser for the VLT adaptive optics laser PARSEC was shipped to Chile. A major intervention on Unit Telescope 4 (UT4) was carried out early in the year to prepare it for the arrival of the components of the Adaptive Optics Facility. The Paranal team was also instrumental in recovering from a failure of the hydrostatic bearings on UT4 in September, through a dedicated around-the-clock effort that was much appreciated all round. Both VISTA and the VST are in regular operation and produce exciting science. The overall efficiency is still being improved in good coordination with the Principal Investigators and the Public Survey Panel. The ESO telescopes continue to be highly oversubscribed and the scientific productivity increased once again. Discoveries included a planet orbiting our nearest star system, Alpha Centauri, with HARPS; the most powerful quasar by X-shooter; and the measurement of the inner structure of a quasar with unprecedented sharpness, provided by intercontinental very long baseline

millimetre interferometry with the involvement of APEX.

The financial situation of the entire programme is under pressure for a number of reasons beyond ESO's control, some long term and some short term. The latter required austerity measures to be implemented in September, with the prospect that these could be lifted by late 2013. The longer term threats to the finances of the Organisation are being addressed in a number of ways that

will enable ESO to pursue its ambitious programme and start the construction of the E-ELT.

Early in the year, the results of a staff engagement survey carried out by an external company were presented. These showed that ESO is doing well in many areas, including overall engagement, but that there is room for improvement in several directions. The management team drew up a global action plan, as a result of which good progress was made

during the year in the areas of leadership, internal communication, and performance management, with further steps planned for 2013.

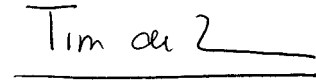

Tim de Zeeuw
ESO Director General



This VLT image of the Thor's Helmet Nebula was taken on the occasion of ESO's 50th anniversary, 5 October 2012, with the help of Brigitte Bailleul — winner of the *Tweet Your Way to the VLT!* competition.

ESO/B. Bailleul

On the evening of 11 October 2012 a Gala event to celebrate the 50th anniversary of the European Southern Observatory took place in the Kaisersaal of the Munich Residenz in Germany. To mark the occasion, senior representatives of the ESO Member States and its host nation Chile, among them seven Ministers and two Ambassadors, and of the observatory itself, signed a prototype mirror segment of the European Extremely Large Telescope.

Austria *John*

Belgium *[Signature]*

Brazil

Czech Republic *Jan Kubisa*

Denmark *Peter Gram*

Finland *Peter Hein*

France *Emmanuel*

Germany *Christoph Hees*

Italy *Franco*

Netherlands *[Signature]*

Portugal *Carsten*

Spain *Chela*

Sweden *Johan*

Switzerland *Walter*

United Kingdom *Tim*

Chile



Science



Research Highlights

Birth and evolution of massive stars

ESO's facilities continue to provide exciting science results. As part of the 50th anniversary celebrations, the ESO@50 workshop examined the scientific successes of the past, today's challenging questions and promises for the future. It also very nicely delineated the transition of ESO from an optical/infrared to a multi-wavelength organisation. The celebrations also provided an opportunity to present ESO to a wider audience through, amongst other channels, two books and a full-length movie.

The scientific career path at ESO has been reformulated in the new Astronomer Charter. The Fellowship programme was assessed through a questionnaire that collected the views of all former and current ESO Fellows. Overall, the programme is seen as extremely successful and important for scientific career development. The procedures and validity of the observing proposal selection process were evaluated through a working group whose report came to the conclusion that the overall system is still valid and should be amended only through small changes. ESO's goal of providing the best and most effective service to the astronomical community in its quest for new discoveries is unchanged.

The research highlights reported in this section are designed to complement the press releases (<http://www.eso.org/public/news/archive/year/2012/>) by providing an overview of progress in several selected subject areas in which ESO facilities have been used to provide substantial input.

Some revolutionary changes in our understanding of how massive stars are born and evolve have taken place over the past few years, and several of these have been driven by observations made with ESO telescopes.

With masses larger than 15 times that of the Sun, stars of spectral type O are rare and short-lived. Nevertheless, by virtue of their high luminosities, strong stellar winds and catastrophic demise, massive stars heat and enrich the surrounding gas clouds from which new generations of stars form, and so drive the chemical evolution of galaxies. Massive stars end their lives in luminous explosions, as core-collapse supernovae or gamma-ray bursts (GRB), which can be observed throughout most of the Universe.

In the past decade, and largely owing to observations made with ESO telescopes, it has become clear that a large fraction of massive stars are in binary systems. What was not known, however, was whether and to what extent the evolution of these massive stars in binaries was affected by the presence of a companion. Thus critical parameters, such as the shape of the initial mass function (discussed in the 2011 Annual Report), were

determined assuming that single and binary stars of high mass evolve in the same way.

In a binary system, however, the evolutionary path of a massive star may be drastically altered by the presence of a nearby companion. Since stars expand as they evolve, those in binary pairs with *short* orbital periods (e.g., up to about 1500 days) exchange mass. The more massive star of the pair can be stripped of its entire envelope, resulting in the loss of much of its original mass. The companion star gains mass and angular momentum, triggering mixing processes in the stellar interior that modify its evolutionary path. In very close binaries, the two stars may even merge. The nature of the binary interaction is largely determined by the initial orbital period and mass ratio. The relative roles of interaction scenarios and the overall importance of binary versus single-star evolution have so far remained uncertain because of the paucity of direct measurements of the intrinsic distributions of orbital parameters.

Spectroscopic VLT observations of the O star population in six nearby galactic open stellar clusters have, for the first

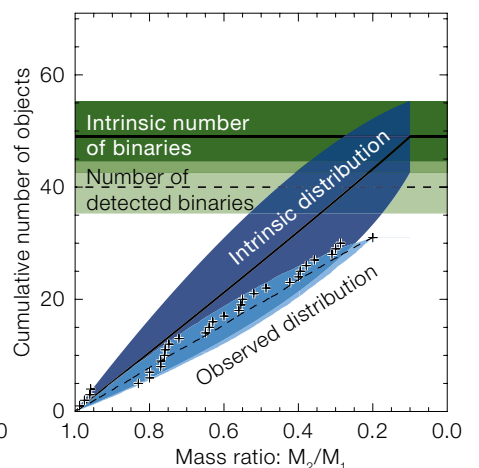
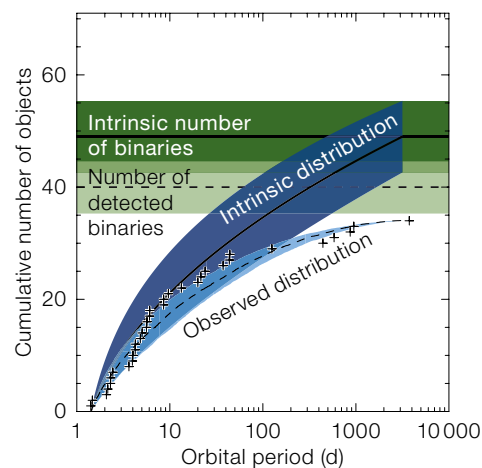

This figure illustrates the way in which the observed number of binaries can be used to derive the intrinsic distributions with orbital period and mass ratio. It shows the cumulative number distributions of logarithmic orbital periods (left) and mass ratios (right) for the sample of 71 O-type objects, of which 40 are identified binaries. The horizontal solid lines and the associated dark green areas indicate the most probable intrinsic number of binaries (49 in total) and its statistical uncertainty. The horizontal dashed lines

indicate the most probable simulated number of detected binaries, which agrees very well with the actual observed number of binaries. Crosses denote the observed cumulative distributions for systems with known periods (34 in total) and mass ratios (31 in total). The lower dashed lines indicate the best simulated observational distributions and their statistical uncertainties. The dark blue areas indicate the most probable intrinsic number distributions and their errors.

Left: This pair of pictures shows a view from the entrance to the Paranal Observatory site in northern Chile, looking towards the summit of Cerro Paranal, as seen in 1987 and at present.

time, allowed the simultaneous measurement of all the relevant intrinsic multiplicity properties in a systematic and homogeneous way from a sample containing five times as many stars as previous investigations and covering the full range of periods and mass ratios relevant for binary interactions.

After detailed modelling to remove statistical biases, the VLT investigation found that about 70% ($\pm 10\%$) of all massive stars are in binary systems (see the figure on page 11). By itself this result is not different from what other investigations, using a variety of methods and telescopes, have estimated. What is new is that the VLT results have, for the first time, allowed the orbital periods of these binary systems to be estimated.

In comparison with previous work, the new observations show no preference for equal-mass binaries, but actually find that the distribution of mass ratios (M_2/M_1 ; right panel) is uniform between $M_2/M_1 = 1$ and $M_2/M_1 \sim 0.3$. More importantly, the new research finds a much steeper distribution of orbital periods than previously thought possible (left panel of the figure on page 11), with a strong preference for shorter periods. The implications of this result are nicely illustrated in the figure above right.

The pie-chart in the centre of the figure above right tells us that the evolution of the vast majority of O stars that are part of a binary system — whether the primary or the secondary — will be significantly affected by mass and angular momentum exchanges with the com-

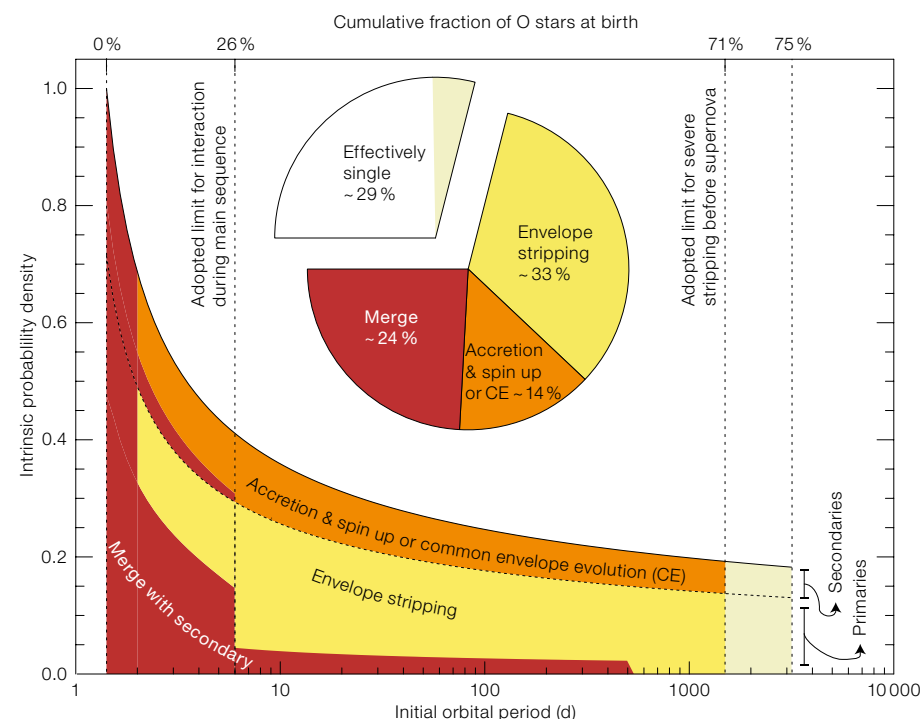

This figure shows the relative importance of different binary interaction processes. All percentages are expressed in terms of the fraction of all stars born as O-type stars, including single O stars and O stars in binaries, either as the initially more massive component (the primary) or as the less massive one (the secondary). The coloured areas indicate the frac-

tions of systems that are expected to merge (red), experience stripping (yellow), or accretion and common envelope evolution (orange). The pie chart compares the fraction of stars born as O stars that are effectively single (white) or in wide binaries with little or no interaction effects (light green) to those that experience significant binary interaction.

panion. But even more striking is the indication that close to one quarter of all O stars (24%) will merge with their binary companion, a process that will completely change the nature of these stars, including possibly explaining how very massive and even extremely massive stars may form.

These results herald a veritable revolution in our understanding of massive stars. In turn, understanding how massive stars form and evolve is paramount to understanding how the ensemble of galaxies — and hence the Universe — acquires its metals. So we should look forward to exciting times ahead.

Gamma-ray bursts

During a period of just a few minutes, gamma-ray bursts become the most luminous objects in the Universe before rapidly fading over a few days or weeks to disappear beyond the reach of even the most powerful telescopes in the world. The burst of gamma rays itself is

extremely short so that the identification of the sources for subsequent follow-up with large telescopes relies on X-ray images taken by instruments aboard the same satellites that detect the gamma radiation. Ever since the first optical counterpart of a GRB was identified in

1997, ESO telescopes have played a central role in unveiling the physical properties of this extraordinary class of objects.

For example, it is now well established that there is a strong connection between the long-duration GRBs and supernova

explosions, in the sense that the progenitors of these GRBs are massive stars that end their lives as core-collapse supernovae of types Ib and Ic. Much has been learned about the astrophysics of GRBs and much of this progress has been reported in previous issues of the Annual Report. So, although ESO telescopes continued to play a leading role in these endeavours in 2012, this time we will report on recent progress in the study of the galaxies that host the GRBs rather than in the GRBs themselves.

Long-duration gamma-ray bursts (LGRB) are powerful tracers of star-forming galaxies that can be used as beacons to probe the early stages of galaxy formation in the Universe. Thus, searches for the optical counterparts of LGRBs have led to the discovery of tens of galaxies at high redshift. The early study of LGRB hosts indicated that an unexpectedly large fraction of them were hydrogen Lyman-alpha emitters — a reliable indicator of active star formation activity — which are substantially less frequent amongst the populations of distant galaxies identified by other methods, in particular by the Lyman-break technique (Lyman-break galaxies; LBG). Larger samples studied with the VLT, however, have shown that this early impression was not correct, and that Lyman-alpha emitters are indeed rare among GRB hosts as well.

A massive study selected 69 southern GRBs for the purpose of studying the properties of their host galaxies using several instruments on the VLT notably FORS1, FORS2, ISAAC and X-shooter. The figure upper right shows the spatial distribution of these objects, compared to all the GRBs discovered by the Swift satellite between roughly 2005 and 2007.

Deep VLT images allowed the identification of the hosts of 32 previously unidentified bursts which, combined with previous work, provided a sample of 54 GRBs with secure host identifications. These galaxies are generally rather faint, reaching magnitudes of almost 28 in the *R*-band. This is illustrated in the lower right figure for a subsample of 17 objects for which the afterglows were originally seen by the X-ray detectors on board Swift.

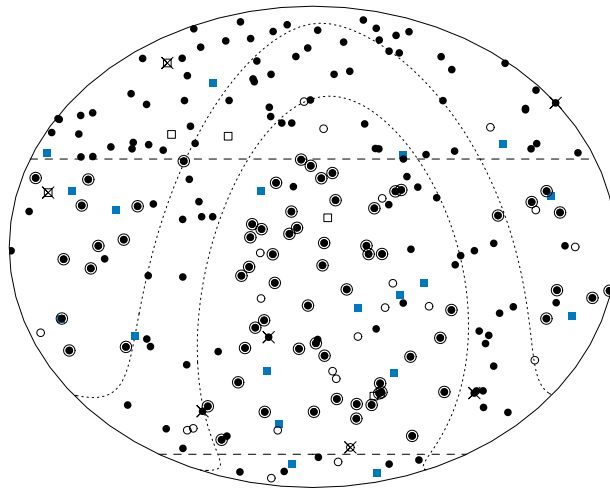

All-sky map of the 236 GRBs discovered by the Swift satellite between 2005 and 2007. The circles are long-duration bursts, and the squares short bursts, which generally do not trace distant galaxies. The complete sample studied by the VLT is indicated in red.

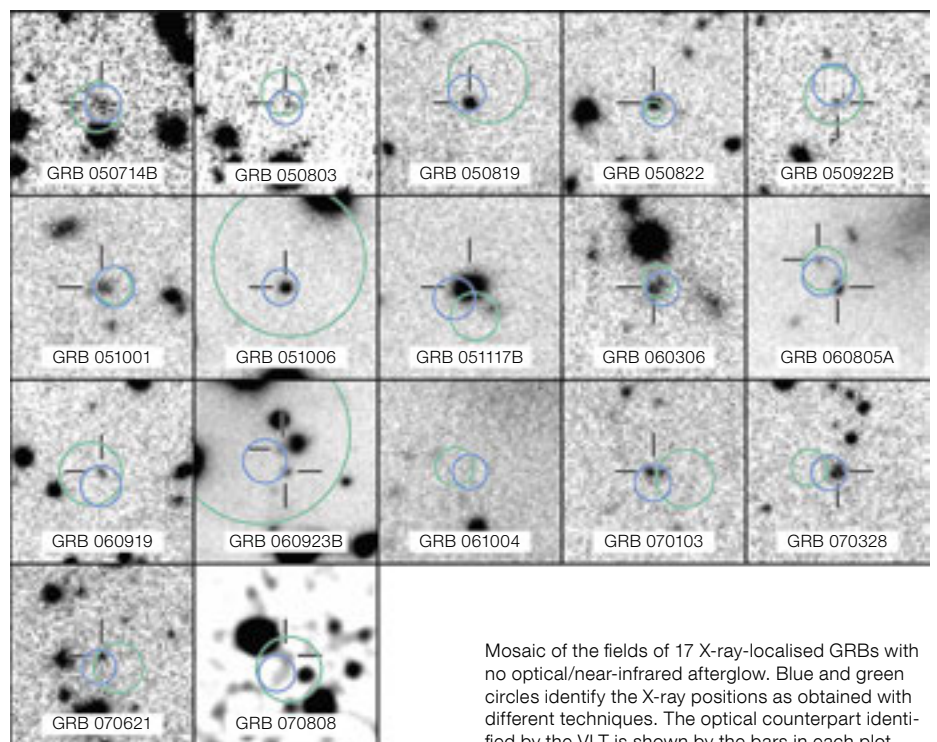

Mosaic of the fields of 17 X-ray-localised GRBs with no optical/near-infrared afterglow. Blue and green circles identify the X-ray positions as obtained with different techniques. The optical counterpart identified by the VLT is shown by the bars in each plot.

A crucial step in investigating the properties of the host galaxies is to measure their redshifts. By combining the new VLT observations of the hosts with previous prompt observations of the afterglows — mostly obtained using the VLT rapid-response mode, which is absolutely essential given the short duration of the afterglow phase — redshifts for 53 of the original sample of 69 bursts were secured.

The resulting sample of GRB hosts provided, for the first time, an unbiased sample where the statistical properties of this class of galaxies can be studied free from the selection effects that have plagued previous investigations. A particularly interesting issue, outlined above, is the detection of Lyman-alpha emission lines. To that end, deep FORS1 spectroscopy was obtained for 20 of the 27 objects with redshifts in the range $z = 1.8-4.5$ (for which Lyman-alpha can

be detected within the spectral grasp of FORS1). Two-dimensional (position/wavelength) plots of the relevant portions of these spectra are shown in the figure on the right.

This same figure shows that only 7 of the 20 objects, 35%, have a statistically significant detection of Lyman-alpha. It also shows that in these seven cases the line is shifted relative to the systemic velocity of the galaxy (indicated as $V_{rest} = 0$) by several hundred kilometres per second. This suggests that the emission originates in a wind that may possibly be driven by a starburst in the host galaxy. However, the strength of Lyman-alpha indicates relatively low rates of star formation in these galaxies as compared, for example, to Lyman-alpha emitters identified using narrowband imaging filters on the VLT. This appears to indicate that, contrary to what was previously thought, LGRB hosts could contain substantial amounts of dust. Alternatively, it may be that LGRBs do not occur at high redshifts in the youngest galaxies.

Another study, using extremely deep infrared exposures with HAWK-I, has the aim of identifying the hosts of LGRBs in a sample of three even higher redshift ($z > 5$) objects.

The resulting images shown in the figure below — probably the deepest ever taken with HAWK-I — all resulted in negative detections. A similar result was obtained by a third team using deep Hubble Space Telescope (HST) images of a sample of six GRBs at $z > 5$.

While these images of empty sky are quite different, and much less exciting, than the beautiful images of celestial

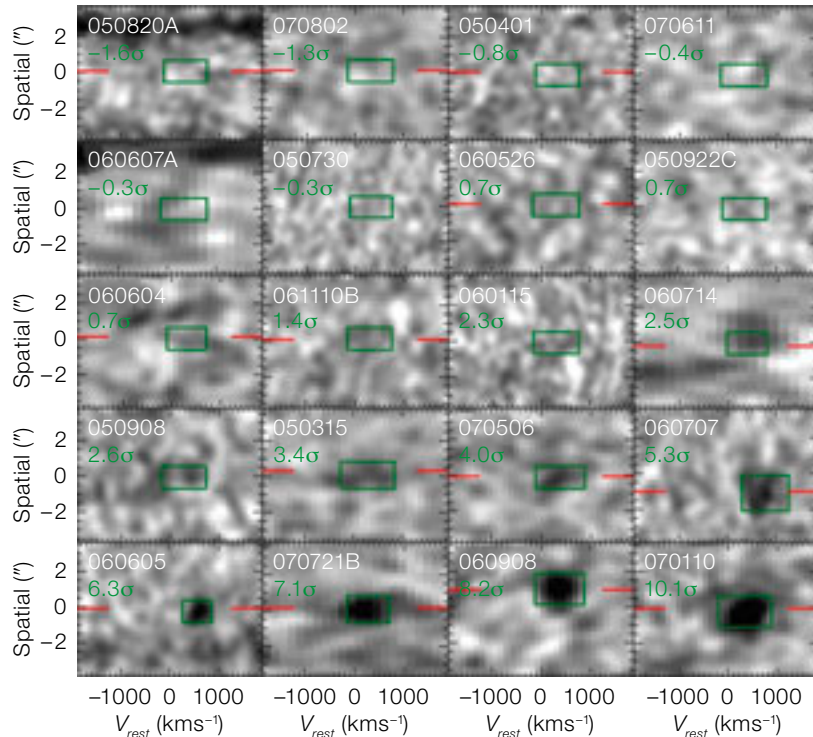

Cut-outs of the FORS1 spectra for 20 GRB hosts of redshifts z between 1.8 and 4.5. The expected regions for Lyman-alpha are shown by the green

boxes, and this illustrates the spatial extension of the line-emitting regions.

images from the VLT (or HST) that we have become accustomed to seeing in reports and in press releases, they nevertheless serve to illustrate the fact that, in science, negative results (in this case blank images) may also provide important and useful information, a fact that is sometimes disregarded by time allocation committees. In this particular case, the negative detection is telling us that if our assumption that LGRBs are good tracers of the sites of star formation at high- z is correct, much — and probably the majority of — star formation at high- z takes

place in small galaxies that are too faint to be detected with even the most powerful telescopes. Since their star formation rates are low, LGRB hosts are either low-mass galaxies or, contrary to what has hitherto been assumed, are very dusty, which would suggest a high metal content. ALMA 345 GHz observations of the host galaxies of GRB 021004 ($z = 2.3$) and GRB 080607 ($z = 3.0$) detected the higher redshift galaxy but not the other one. Neither of the two galaxies are rapidly star-forming and this is consistent with both being at the faintest end of the

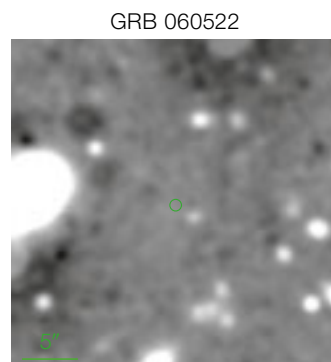
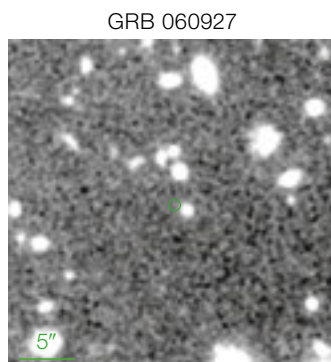
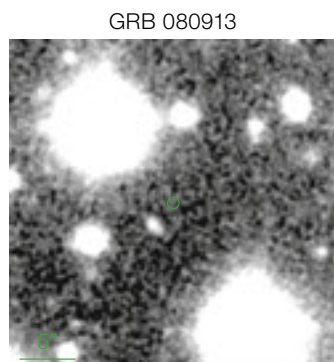

HAWK-I images of three GRBs at $z > 5$. The position of the source, obtained from imaging of the afterglow, is indicated by the green circle at the centre of each figure.

dusty galaxy distribution responsible for the submillimetre background. In both cases the infrared luminosity, $L_{IR} \lesssim 4 \times 10^{11} L_{\text{Sun}}$.

This result could, however, contradict new polarimetric observations of the afterglow of one GRB at $z \sim 1$ obtained with the VLT using the rapid-response mode, which show no traces of interstellar polarisation. On the other hand, GROND on the MPG/ESO 2.2-metre telescope on La Silla, has detected strong dust silicate features in the restframe ultraviolet spectra of distant LGRBs, providing direct evidence for dust in their host galaxies.

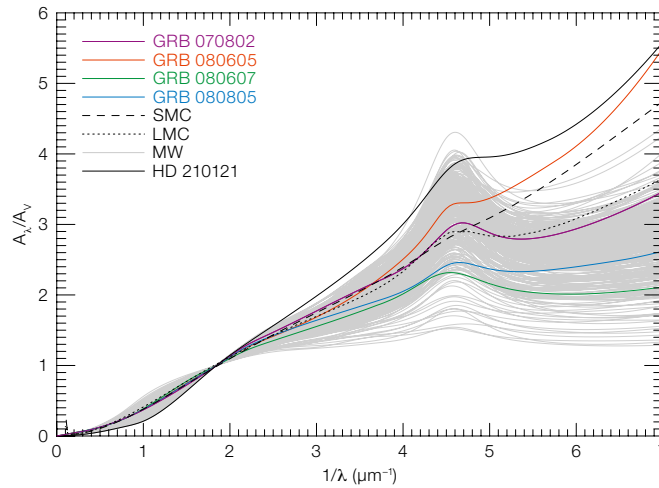

Extinction curves — the amount of light of different colours removed on the path to Earth — of four GRBs as indicated in the legend. Various extinction curves observed in the Milky Way and the Magellanic Clouds (SMC and LMC) are shown for comparison. Among the many lines of sight in the Milky Way, that of HD120121 is particularly outstanding.

The history of galaxy formation in the Universe

The standard model (known as Λ CDM; Lambda Cold Dark Matter), used to explain the formation of structure in the Universe, postulates that the Big Bang produced the vast number of particles that interact with other particles only through gravity and the weak force (β -decay). These weakly interacting massive particles (WIMPs) do not interact either with electromagnetic or nuclear forces, and so cannot be seen directly or detected through strong interactions with atomic nuclei. Thus WIMPs are excellent candidates to explain the approximately 25% of the energy density of the Universe that is invisible: dark matter. The Λ CDM paradigm postulates that most of the remainder of the energy density of the Universe is in the form of a mysterious component called dark energy or the cosmological constant (Λ). The standard model also postulates — guided by observations — that dark matter is cold in the sense that its particles move at velocities that are small compared with the speed of light: hence Cold Dark Matter.

In the Λ CDM scenario, the first structures that grow from the primordial density fluctuations, imprinted on the Universe by quantum processes in the Big Bang, are

dominated by dark matter responding to gravitational forces. Thus, clusters of galaxies, galaxies and ultimately stars, form inside these dark matter haloes. The gas — from which stars will eventually form — is initially very hot and falls into these haloes, which act as gravitational traps, and there the gas must cool down before stars are able to condense. The processes governing the transformation of hot gas into stars involve complex physical and chemical interactions that are rather difficult to calculate from first principles. Therefore, although the physics leading to the formation of dark matter haloes is reasonably well understood, modelling the formation of galaxies and stars is a notoriously difficult problem that requires the use of empirical recipes inferred from observations.

Thus, observations are essential in guiding our first steps in understanding how galaxies form. The properties of galaxies are observed to evolve very little — if at all — from redshifts $z \sim 1$ until the present. This means that, if we want to catch evolving galaxies in the act, we must observe large numbers of distant galaxies in order to triage outliers and derive general laws. This implies large cosmological surveys, and many observatories

have devoted significant amounts of telescope time over the past 20 years to conducting large imaging surveys. In order to maximise their potentialities, imaging surveys must be followed up by the spectroscopic observations needed to determine galaxy redshifts with the required accuracy.

Two Large Programmes on the VLT using VIMOS have been collecting redshifts for large numbers of galaxies in different areas of the sky: the VIMOS VLT Deep Survey (VVDS) and zCOSMOS, a Large Programme to measure the redshifts of about 30 000 galaxies in the HST Cosmic Origins field. VVDS and the first part of zCOSMOS — zCOSMOS-bright — have now been completed after several years of observations. A number of interesting results from both surveys have been published in the past two years, mostly devoted to piecing together the puzzles relating to galaxy formation in the Universe.

When plotted in a colour–magnitude diagram, galaxies define a deceptively simple distribution: red galaxies (with low star formation rates) concentrate along a narrow strip in colour known as the red sequence, whereas blue (star-forming;

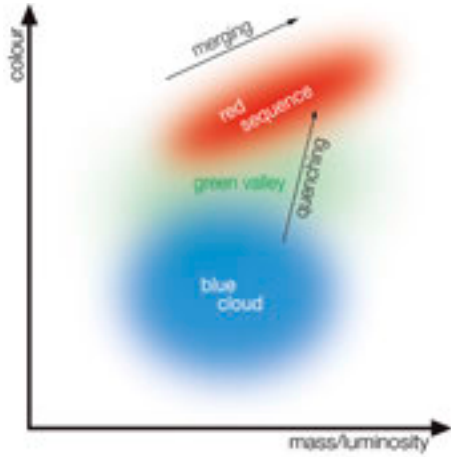

Schematic representation of the colour-magnitude diagram of galaxies.

mostly spiral and irregular) galaxies occupy a much broader region called the blue cloud, with few galaxies distributed between them in the green valley. The figure above (left) shows a schematic of this distribution.

The paucity of galaxies in the green valley implies that galaxies evolve from the blue cloud (star-forming) to the red sequence (passive) in a rather short time, so there must be some, not yet fully understood, mechanism that inhibits, or quenches, the star formation very efficiently. The nature of quenching has therefore become one of the holy grails of modern extragalactic astronomy and is one of the problems being tackled by zCOSMOS.

Quenching, according to recent zCOSMOS results, comes in three flavours: mass quenching, environmental quenching, and merging quenching (see the figure above, right). Merging occurs when the conditions for the collision between two galaxies, or two dark matter haloes, are such that the two merge to become a larger one. Naturally, therefore, a great deal of effort has been devoted to studying the properties of galaxy pairs in both VVDS and zCOSMOS. Analysis of the first 10 000 galaxies of the zCOSMOS-bright survey showed that galaxies in pairs contribute a significant fraction of the star formation in the Universe, as shown in the figure above, right.

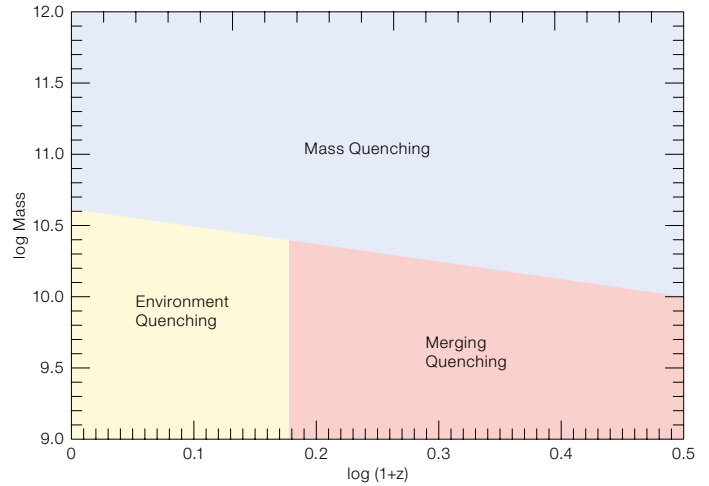
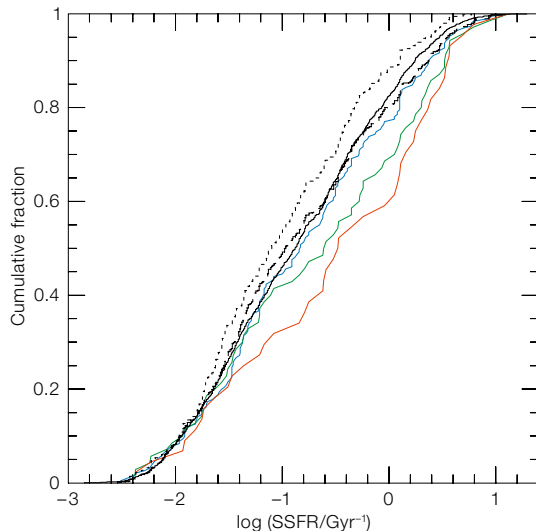
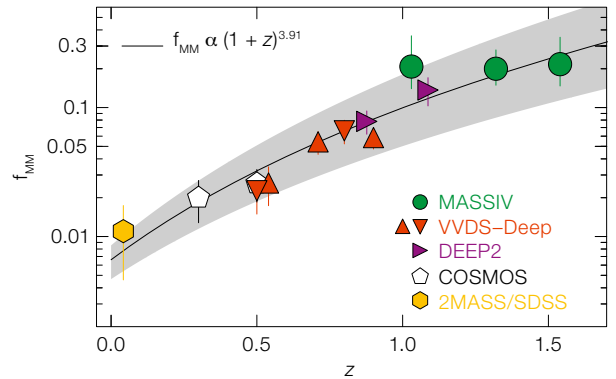

Diagram showing the dominant mechanism for the quenching of galaxies as a function of mass and redshift in typical environments. Merging and environment quenching, although very distinct observationally, both reflect the underlying merger of dark matter haloes.

Mergers come in two flavours depending on the mass ratio R of the two merging galaxies: minor mergers, where the $R \ll 1$, and major mergers for which $R \approx 1$. Major mergers are believed to be a mechanism whereby spiral galaxies (discs) are transformed into elliptical galaxies (spheroids). An ambitious programme to study the kinematics of VVDS galaxies with the VLT integral field unit spectrograph SINFONI (MASSIV; Mass Assembly Survey with SINFONI in VVDS) suggests that the fraction of galaxies that have undergone major merger events since $z = 1.5$



Left: Comparison between specific star formation rate (SSFR) distribution of isolated galaxies compared to that of galaxies in pairs of different separations as indicated by the colours: blue: $< 100 h^{-1} \text{ kpc}$; green: $< 50 h^{-1} \text{ kpc}$; red: $< 30 h^{-1} \text{ kpc}$.



Gas-rich major merger fraction of $M^* \sim 10^{10-10.5} M_{\odot}$ galaxies as a function of redshift.

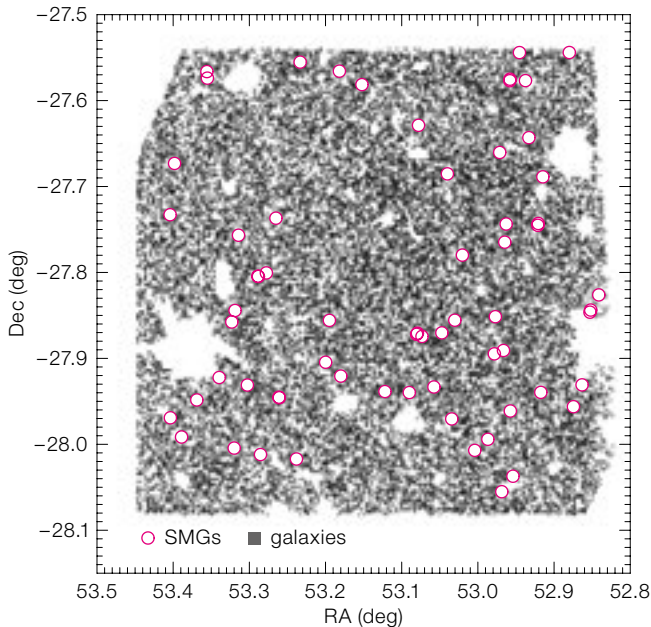

Distribution of 50 LESS (LABOCA) SMGs with redshifts $1 < z < 3$ and $\sim 50\,000$ Spitzer/IRAC galaxies in the Extended Chandra Deep Field South. The SMGs are shown individually while the density of galaxies is given by the greyscale.

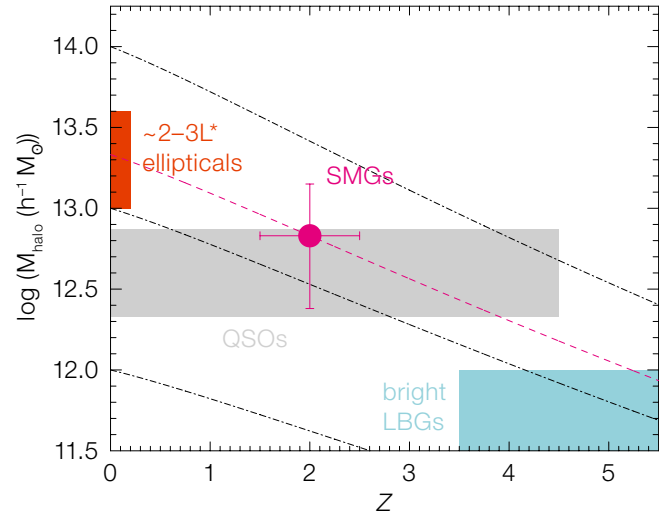

Broad schematic for the evolution of halo mass versus redshift for SMGs, showing the approximate halo masses corresponding to likely progenitors and descendants of SMGs. Lines indicate the median growth rates of haloes with redshift. SMG host haloes are similar to those of QSOs at $z \sim 2$, and correspond to bright LBGs at $z \sim 5$ and massive ellipticals at $z = 0$.

increases sharply with redshift (see the figure below, right) indicating that major mergers have played a significant role in the build up of the red sequence of massive elliptical galaxies. These results must be confronted with observations that the luminosity function of massive galaxies (i.e., the density of galaxies as a function of redshift) has not evolved significantly since $z \sim 1$, which would imply that mergers affect mostly the sizes of elliptical galaxies, but not their luminosities.

Much progress in this field is expected when the analyses of zCOSMOS-bright and the ongoing zCOSMOS-faint surveys, which will reach to $z = 3$, are completed.

Another powerful way of studying the formation of massive red-sequence ellipticals is to directly observe their progenitors at high redshift, and, in particular, a class of massive star-forming galaxies known as submillimetre galaxies (SMGs) which, being very dusty, emit most of their luminosity at far infrared and submillimetre wavelengths. Again, large surveys are needed to investigate the

ensemble properties of this class of galaxies, and the Large Bolometer Array Camera (LABOCA) on APEX provides one of the best suited for this kind of study. But even with large bolometer array cameras the largest deep map with LABOCA (called LESS) shown in the figure above (left) covers a mere 0.35 square degrees.

A sophisticated clustering analysis of the 50 galaxies in the LESS survey with redshifts between $z = 1$ and $z = 3$, allowed the typical masses of the dark-matter haloes of these galaxies, $M_{halo} \approx 6 \times 10^{12} M_{\odot}$ (where M_{\odot} is the mass of the Sun) to be inferred. This result is quite similar to the masses inferred for the dark matter haloes of the hosts of QSOs (quasars). This provides strong support to evolutionary scenarios in which powerful starbursts and QSOs occur in the same systems.

Numerical simulations of the evolution of dark matter haloes of these masses provide a fairly accurate picture of the evolution of massive elliptical galaxies from $z \sim 5$ until today, shown in the figure above (right).

Present-day ($z = 0$) massive elliptical galaxies are the descendants of SMGs at $z = 2-3$, which in turn originate in bright LBGs at even higher redshifts. The LABOCA survey also shows that the powerful starbursts in SMGs represent a short-lived but universal phase in the evolution of massive galaxies, associated with the transition between cold, gas-rich, star-forming galaxies (the blue cloud) and passively evolving systems (the red sequence).

With its sensitivity and angular resolution, ALMA is the prime instrument to study these faint star-forming galaxies at high redshift. ALMA Cycle 0 observations of LESS sources have shown that most of the highest luminosity SMGs are actually multiple systems, implying that the submillimetre luminosity function of high redshift galaxies falls off more sharply than previously thought from single dish surveys. Another notable early result from ALMA is the detection of [N II] 205 μm line at $z = 4.76$ which, in combination with the previous detection of the [C II] 158 μm line from APEX, allowed the constraint of the metallicity of this system to be close to the Solar value.

Chemistry of the interstellar medium and prebiotic molecules

The chemical enrichment of the interstellar medium and the chemistry of complex and possibly prebiotic molecules has always been one of the major goals for the ALMA Observatory right from its conception. The first year of ALMA science has demonstrated the power of this revolutionary facility in this field. Several new results were published based on the ALMA science verification datasets on the Orion KL region and on the young solar analogue protostellar system IRAS 16293-2422.

An important highlight was the detection of abundant glycolaldehyde, a simple sugar connected with ribonucleic acid (RNA) chemistry, in IRAS 16293-2422. ALMA Bands 9 and 6 observations revealed at least 13 transitions from this simple sugar in the gas phase. The spatial distribution and kinematics of the molecular gas show that it is inflowing into the inner ~ 30 astronomical units of the system and so is located in the regions where planet formation is expected to occur. These initial results, shown in the figure above left, prove that prebiotic molecules can be efficiently produced during the early phases of star formation and delivered into the protoplanetary discs and planets.

Water is also a key molecule for life on Earth. While the Herschel satellite has detected water in a number of protostellar environments, ALMA is proving to be the key instrument with which to detect the rare isotopes and to spatially resolve the emission. The ALMA observations reveal the regions where the ice mantles are sublimated close to the protostars and measurements of the isotopic abundance ratios seem to suggest that the difference between the isotopic abundances in the oceans on Earth and

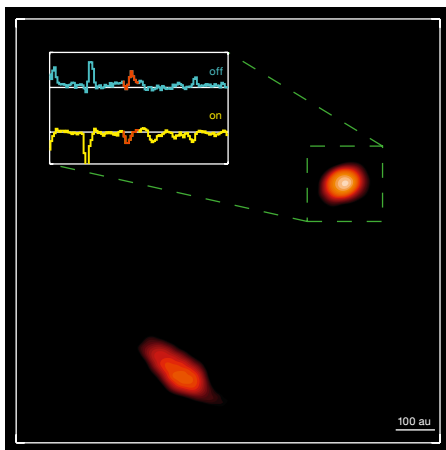

Left: ALMA Band 9 continuum image of IRAS 16293-2422. The inset shows one of the glycolaldehyde lines detected by ALMA (in red). The yellow spectrum is from the peak of the continuum emission shown in the image, where a redshifted absorption is apparent. This is the signature of inflow towards the inner regions of the system. The blue spectrum shows the more extended region of emission. Right: Lines of water isotopologues (marked in red) detected in IRAS 16293-2422. The lower four spectra are from the ALMA Band 9 dataset.

those in the discs and envelopes around young protostars is much less than previously thought. The ALMA measurement of $\text{HDO}/\text{H}_2\text{O}$ (9.2 ± 2.6) $\times 10^{-4}$ is only a factor of three higher than the value measured on Earth and is consistent with the values measured in Solar System comets (see figure above right).

Another very important early contribution from ALMA to the understanding of the chemical enrichment of the interstellar medium is related to the study of the mass loss in the asymptotic giant branch (AGB) star R Sculptoris. The ALMA CO(3–2) observations in Band 7 (shown in the figures below) reveal the detailed mass-loss history from this evolved star since the last thermal pulse, approximately 1800 years ago. ALMA's sensit-

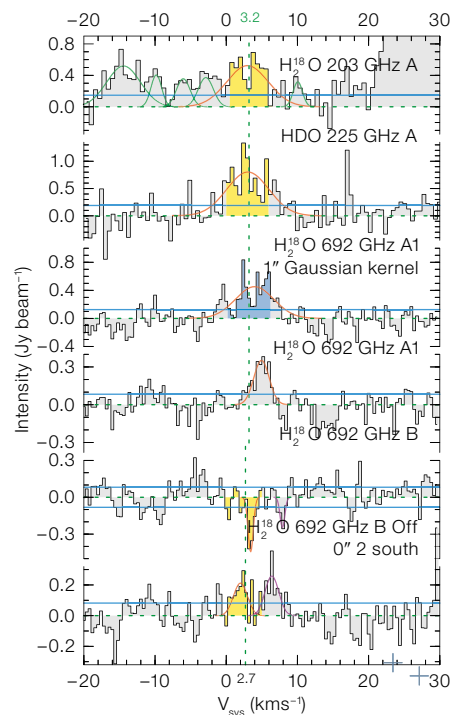

ivity allowed the detection and measurement of the lower mass-loss rate in the wind following the large event connected to the thermal pulse. The remarkable spiral pattern detected in the wind shows that the star that is losing the mass is a member of a binary system. Detailed smoothed-particle hydrodynamical modelling of the observations shows that 10% of the mass is expelled during the thermal pulse event and approximately 40% in the following 1800 years. This leads to the conclusion that approximately three times more mass is returned to the interstellar medium in this phase than previously thought. Surprisingly — and contrary to model predictions — the detached shell around R Sculptoris does not show any measurable slowing down since the ejection.

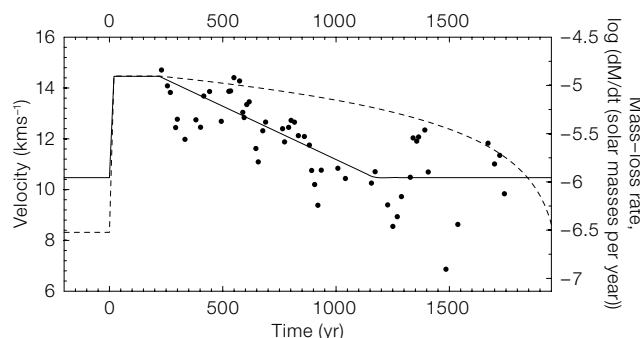
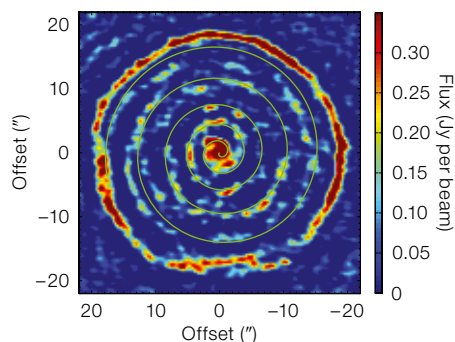

Left: ALMA Band 7 CO(3–2) rest velocity channel map of the AGB star R Sculptoris. The detached shell and the inner spiral emission are shown together with the prediction of the best-fit spiral model. Right: Mass-loss history (dashed line) and velocity (solid line) of the best-fit model to the CO(3–2) data. The dots show the measured velocities from the molecular gas emission.

Formation and early evolution of planetary systems

Planet formation is thought to occur within protoplanetary discs in the first few million years of pre-main sequence evolution of the stellar systems. The most widely accepted scenario involves the growth of solids, originally in the form of interstellar dust grains, from micrometre-sized particles to pebbles, boulders and planetesimals. This phase is followed by the growth to planetary-sized rocky cores and possibly gas accretion for the formation of giant planets. The process of planet formation is closely related to the disc properties and their evolution as disc dissipation processes remove the raw material for assembling planets. Newly formed giant planets interact with the disc, possibly accelerating its evolution. While infrared observations mostly trace the disc inner regions and atmosphere, millimetre waves probe the outer regions of the disc and the disc mid-plane, tracing the bulk of the cold and dense material in the disc. High angular resolution observations of discs in the millimetre continuum and spectral lines allow us to trace the dust properties and the gas physical, chemical and kinematical structure during the planet formation process.

ALMA observations of the dust emission from the mid-plane of a disc surrounding a young brown dwarf demonstrated that grain growth to pebble size can also be efficient in these environments. This finding challenges current models of grain growth and evolution, which did not predict efficient growth to large sizes in these systems, and suggests that rocky planet formation in brown dwarf systems is possible.

The disc–planet interaction is thought to shape the evolution of the late phases of disc evolution, known as the transitional disc and debris disc phases. Key results were obtained with ALMA on the dust and gas distribution in discs as shaped by young planetary systems. The ALMA Band 7 observations of the debris disc surrounding the nearby star Fomalhaut constrain the properties of the planets shepherding the dust ring to be in the superEarth mass range. This result is not consistent with the previously detected planet candidate inside the dust ring, which was also not confirmed by subsequent observations.

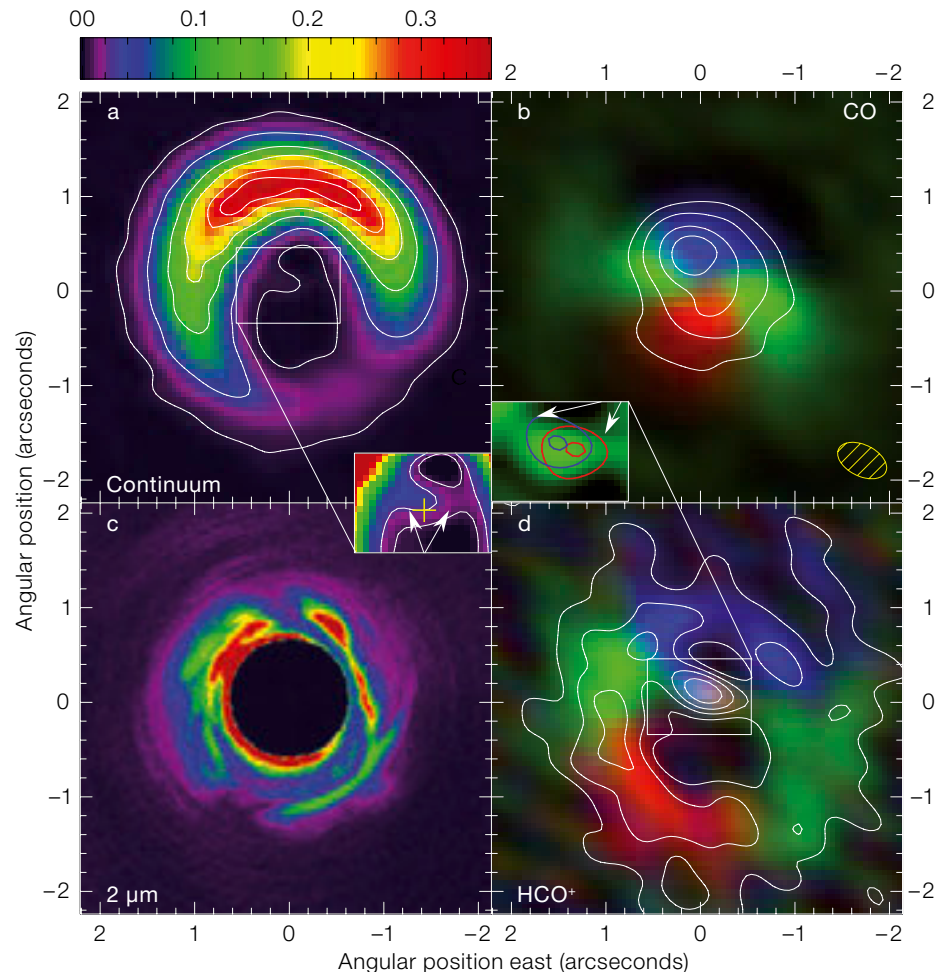

Top left: ALMA Band 7 continuum emission image of HD 142527, showing the uneven distribution of dust grains in the outer disc. Bottom left: Near-infrared coronagraphic image of HD 142527 showing the disc's upper atmosphere asymmetries. Top right: ALMA CO(3–2) total intensity (contours) and velocity

map (colour scale) showing that the inner dust-evacuated cavity of the disc contains abundant molecular gas. Bottom right: ALMA HCN(4–3) intensity (contours) and velocity map (colour scale) showing the inflow of dense gas from the outer disc to the inner regions of the system.

ALMA Band 7 observations of the protoplanetary disc surrounding the intermediate-mass pre-main sequence star HD 142527 confirmed the presence of a large gap in the dusty disc, most likely to be the result of the presence of one or more massive planets (see figure above). The CO(3–2) observations confirm the presence of molecular gas in the disc across the gap, consistent with the planets being the cause of clearing most of the high density gas and dust in the gap. Other clearing mechanisms, such as photoevaporation, would completely remove the gas from the gap and the inner disc. ALMA HCN(4–3) observations

of the dense gas revealed the presence of dense gas flows connecting the outer disc to the inner disc and providing a supply of material that accretes onto the central star. Models of disc–planet interaction do predict that planets may be involved in the transfer of material from the outer disc to the inner regions of the system.

References

The following papers were used as sources for the science highlights.

Basa, S. et al. 2012, A&A, 542, A103
Boley, A. C. et al. 2012, ApJ, 750, L21
Casassus, S. et al. 2013, Nature, 493, 191
Chini, R. et al. 2012, MNRAS, 424, 1925
De Ugarte Postigo, A. et al. 2012, A&A, 538, A44
Hickox, R. C. et al. 2012, MNRAS, 421, 284
Hjorth, J. et al. 2012, ApJ, 756, 187
Jakobsson, P. et al. 2012, ApJ, 752, 62
Jørgensen, J. K. et al. 2012, ApJ, 757, L4
Kampanyk, P. 2013, ApJ, 762, 43
Kruhler, T. et al. 2012, ApJ, 758, 46
López-Sanjuan, C. et al. 2012, A&A, 548, A7
Maercker, M. et al. 2012, Nature, 490, 232
Milvang-Jensen, B. et al. 2012, ApJ, 756, 25
Nagao, T. et al. 2012, A&A, 542, L34
Peng, Y.-J. et al. 2010, ApJ, 721, 193
Pentericci, L. et al. 2011, ApJ, 743, 132
Persson, M. V. et al. 2013, A&A, 549, L3
Ricci, L. et al. 2012, ApJ, 761, L20
Rossi, A. et al. 2012, A&A, 545, A77
Sana, H. et al. 2012, Science, 337, 444
Svensson, K. M. 2012, MNRAS, 421, 25
Tanvir, N. R. 2012, ApJ, 754, 46
Wiersema, K. 2012, MNRAS, 462, 2
Wang, W.-H. et al. 2012, ApJ, 761, L32
Zafar, T. et al. 2012, ApJ, 753, 82

The Lupus 3 dark cloud and associated hot young stars. This cloud lies about 600 light-years from Earth in the constellation of Scorpius (The Scorpion).

ESO/F. Comeron



Offices for Science

The Offices for Science in Garching and Santiago endeavour to support the scientific staff and activities at ESO, as well as its wider community and projects. This support takes many forms, including hosting and training junior researchers, and fostering scientific collaborations with the Member States.

The ESO astronomers — about 90 Faculty astronomers and 25 scientists — apply their know-how and areas of expertise to provide top-level services to various parts of the organisation, from assisting with the projects and instrument development to supporting operations at the La Silla, Paranal and Chajnantor observing sites. Forty ESO Fellows are also closely involved in the operational and instrumental aspects of the observatory, while the 50 ESO Students are building their expertise, advised by ESO staff and sometimes also being mentored by ESO Fellows.

For these supporting and collaborative activities to be a success, it is a requirement that the staff remain at the forefront of modern astronomy and instrumentation. This year ESO astronomers have, for instance, contributed to more than 500 research papers by participating in or leading some exciting scientific projects. As notable examples, we should like to celebrate the year's scientific achievements by two ESO astronomers, one based in Germany and one in Chile.

Daniel Bramich, who joined ESO in 2010, is working within the Data Management and Operations Division in Garching as a member of the Science Data Products group. He has considerable expertise in data processing and with analysis techniques. In 2012 Dan's scientific record was impressive, as he managed to publish three first-author papers and more than ten others on various topics including differential imaging analysis, globular clusters and micro-lensing searches for exoplanets. Dan led a study which uncovered a systematic trend in the Sloan Digital Sky Survey (SDSS) photometric data at the level of its target precision, and which should therefore be accounted for when using such datasets. He also played an active role in the selection of new ESO Student and Fellows via his participation in the *ad-hoc* committee

(Fellow–Student Selection Committee) and co-supervised two students himself during that period.

Paranal astronomer Henri Boffin, who moved from Garching to Chile in 2010, had an outstanding scientific year with eight papers published, two of them as first author (including one in the prestigious international journal *Science*). The impact of Henri's research, which combines both observational and theoretical work in the study of close binary stars, was recognised by two ESO press releases this year, as well as numerous successful observing proposals during the Observing Periods P89 and P90. In addition, Henri co-organised the very successful blue stragglers conference in Vitacura, supervised several students, served as co-organiser of colloquia in Vitacura, and continued to be very active in public outreach.

As usual, ESO hosted many visitors this year, including more than 50 with long-term stays of at least one month. We had, for instance, the pleasure of hosting Prof. Joseph Taylor (Nobel Laureate, 1993) at ESO Headquarters in Garching, where he gave a brief but intense account of his career followed by an informal discussion; and Prof. Neil Evans, who significantly helped to strengthen the links between the optical–infrared and submillimetre/radio communities, and stayed for almost a year in Santiago. The ESO facilities in both Santiago and Garching host many astronomers who pass by to contribute to one of the state-of-the-art instrument developments, collaborate, or go observing at one of ESO's sites. This steady traffic provides the opportunity to arrange a broad range of talks, seminars and short oral contributions, covering topics from specific updates on instruments to frontline research and



ESO staff members Daniel Bramich (left) and Henri Boffin (below).





Participants at ESO's 50th anniversary conference.

general public presentations. Such activities make the ESO premises a very special and unique place to be, providing a very attractive scientific environment.

In the context of ESO's 50th anniversary, the Offices for Science arranged a dedicated conference intended to provide an original perspective on the scientific challenges of the coming decade, building on the achievements of the science community using ESO facilities. A conference report was published in *The ESO Messenger*, 150, 67, December 2012.

Conferences organised, co-organised or sponsored by ESO included:

- ALMA Community Days: Early Science in Cycle 1, ESO, Garching, 25–27 June 2012 (http://www.eso.org/sci/meetings/2012/alma_es_2012.html);
 - 30 years of Italian participation to ESO, Rome, 2–3 July 2012 (<http://www.eso.org/sci/meetings/2012/ewass2012.html>);
 - ESO@50 — the first 50 years of ESO, ESO, Garching, 3–7 September 2012 (<http://www.eso.org/sci/meetings/2012/ESOat50.html>);
 - Science from the Next Generation Imaging and Spectroscopic Surveys, ESO, Garching, 15–18 October 2012 (<http://www.eso.org/sci/meetings/2012/surveys2012.html>);
 - ESO Workshop on Ecology of Blue Straggler Stars, Santiago, Chile, 5–9 November 2012 (<http://www.eso.org/sci/meetings/2012/bss2012.html>);
 - The First Year of ALMA Science, Puerto Varas, Chile, 12–15 December 2012 (<http://www.almasc.org/2012/>).
- Joint ESO/IAG/USP Workshop on Circumstellar Dynamics at High Resolution, Foz do Iguacu, Brazil, 27 February–2 March 2012 (<http://www.eso.org/sci/meetings/2012/csdyn.html>);
 - Workshop on Observing Planetary Systems II, Santiago, Chile, 5–8 March 2012 (<http://www.eso.org/sci/meetings/2012/OPSII.html>);
 - 7th Conference on Astronomical Data Analysis (co-sponsored by ESO), Cargèse, Corsica, 14–18 May 2012 (<http://ada7.cosmostat.org/>);



The Director General, Tim de Zeeuw, outlining future perspectives for ESO at ESO's 50th anniversary conference.

The Offices also undertook a web-based survey of current and past ESO Fellows with the goal of assessing the strengths and weaknesses of ESO's Fellowship programme and identifying ways in which the programme could be improved in the future. The response rate was impressive — 174 out of 222 participants responded. The results, which will soon be summarised in an article for *The ESO Messenger*, point to a high level of satisfaction with ESO's Fellowship programme and its value to the ESO community. For example, 87 % of former and current ESO Fellows rated their experience as "excellent" or "very good" and the great majority say that they would definitely recommend an ESO Fellowship to young scientists. As one former Fellow put it, an ESO Fellowship "is a passport to your astronomical future!"

This year has also been quite extraordinary in terms of extending the science programmes that gather together various institutes in the Munich area:

- The Excellence Cluster Universe, which assembles more than 200 physicists and astrophysicists from the Technical University of Munich, the Ludwig Maximilian University of Munich, Max Planck Institutes (MPG) and ESO, was successfully extended for a new five-year period. Going beyond the coordination and top-level research conducted by the Excellence Cluster scientists, this new period will see the advent of the Computational Center for Particle and Astrophysics in Munich, where ESO staff will actively contribute.
- The International Max Planck Research School (IMPRS) programme, a joint international research school to attract and host PhD students, was evaluated by external reviewers in summer 2012. The outcome is impressive: the programme has been praised for its achievements and is being extended for a period of six more years, enabling the training and hosting of the next pool of students, some of whom will develop their research and expertise at ESO Garching.



Participants on the workshop, Science from the Next Generation Imaging and Spectroscopic Surveys, on the stairs of the entrance hall of ESO Headquarters.



The group photo taken at the workshop Circumstellar Dynamics at High Resolution against the splendid backdrop of the Iguazu Falls.

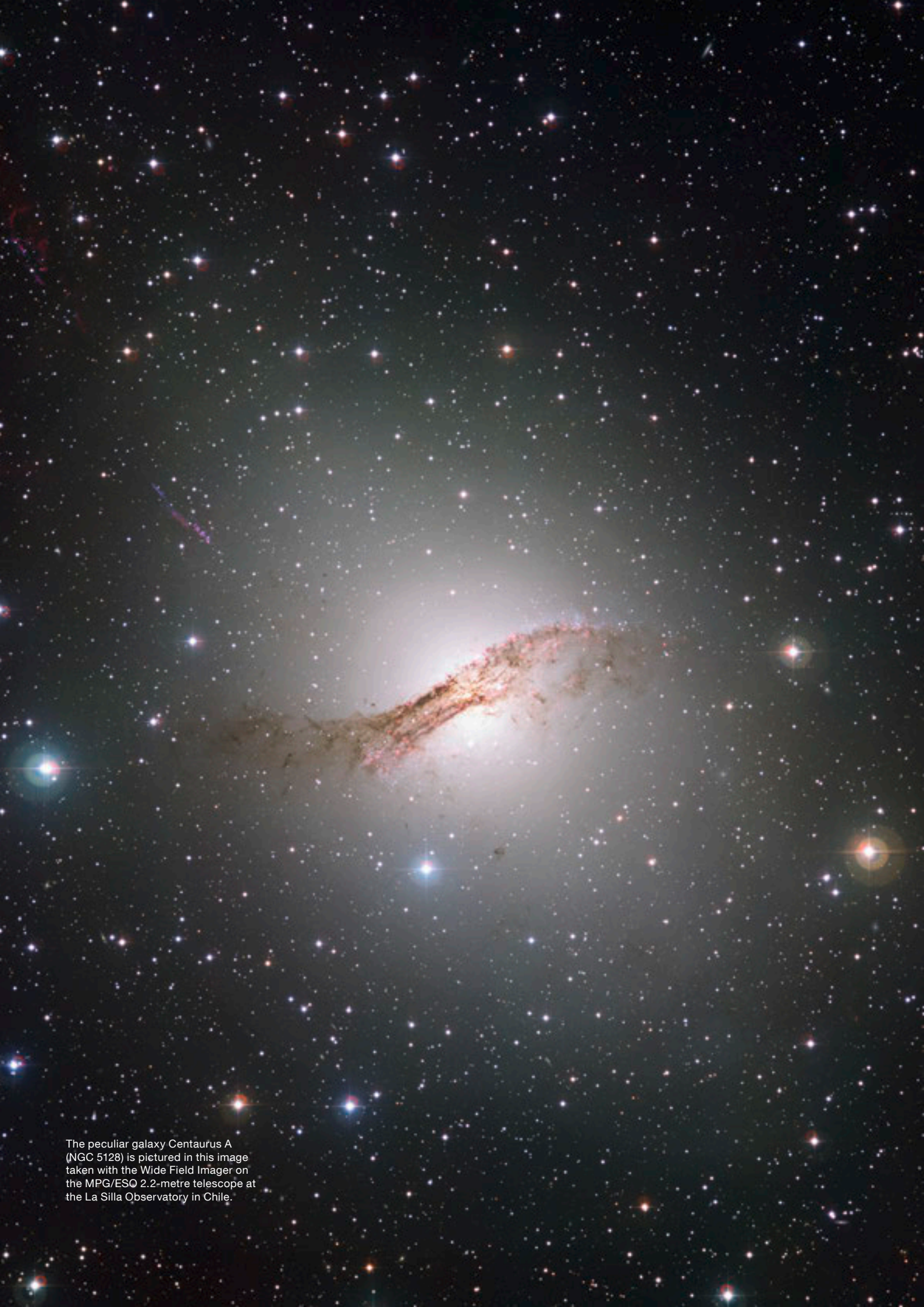

The peculiar galaxy Centaurus A (NGC 5128) is pictured in this image taken with the Wide Field Imager on the MPG/ESO 2.2-metre telescope at the La Silla Observatory in Chile.

Allocation of Telescope Time

The tables show the requested and scheduled resources for ESO Periods 90 and 91 and for ALMA Cycle 1. This is divided into the lengths of time — in nights for La Silla Paranal (LSP) and APEX, but in hours for ALMA — for each instrument/band and telescope.

The numbers for ALMA Early Science Cycle 1 include only ESO Principal Investigator (PI) proposals and the highest ranked projects amongst them. The requested and allocated numbers of runs and amount of time (in hours) per frequency band are reported.

The APEX and LSP numbers include only proposals submitted during the periods of interest. Current Large Programme runs approved in previous periods, Guaranteed Time runs and Public Survey runs are not included. The pressure is computed as the ratio between the requested and allocated time. The last two columns present the total telescope time allocations and the fractions per instrument.



ESO/B. Tafreshi/TWAN (twanight.org)

The crescent Moon setting over the Paranal Observatory in Chile. The earthshine, which is sunlight scattered off the Earth and illuminating the lunar disc, is well seen, as are the planets Mercury and Venus.

Telescope	Instrument	Requested runs	Scheduled runs	Requested time	%	Scheduled time	%	Pressure	Total allocation	%
UT1	CRIRES	101	52	118	16.8%	58	23.7%	2.02	58	23.2%
	FORS2	486	196	585	83.2%	188	76.3%	3.12	193	76.8%
Total		587	248	703		246		2.86	251	
UT2	FLAMES	111	24	174	21.5%	31	16.6%	5.57	91	31.3%
	UVES	182	68	233	28.8%	57	30.0%	4.13	58	19.9%
	X-shooter	320	112	402	49.6%	101	53.4%	3.99	143	48.8%
Total		613	204	809		189		4.29	292	
UT3	ISAAC	50	38	47	12.1%	34	20.0%	1.36	34	17.9%
	VIMOS	187	94	214	55.6%	106	61.8%	2.03	121	63.0%
	VISIR	145	47	124	32.3%	31	18.2%	4.00	37	19.1%
Total		382	179	385		171		2.25	192	
UT4	HAWK-I	163	59	136	21.9%	39	18.0%	3.53	39	17.2%
	NACO	257	134	240	38.6%	108	50.5%	2.22	111	49.2%
	SINFONI	201	63	246	39.5%	68	31.5%	3.64	76	33.6%
Total		621	256	622		214		2.90	225	
VLT	AMBER	127	45	93	35.3%	28	31.1%	3.29	48	25.6%
	MIDI	134	37	66	24.9%	13	14.5%	4.97	42	22.4%
	Special VLT	88	37	105	39.8%	50	54.3%	2.12	97	51.9%
Total		349	119	265		91		2.90	187	
2.2-metre	FEROS	45	35	186	67.0%	106	80.3%	1.75	106	80.3%
	WFI	18	6	92	33.0%	26	19.7%	3.52	26	19.7%
Total		63	41	278		132		2.10	132	
3.6-metre	HARPS	61	64	395	100.0%	176	100.0%	2.25	338	100.0%
Total		61	64	395		176		2.25	338	
NTT	EFOSC2	77	30	318	59.1%	119	67.5%	2.68	190	56.6%
	SOFI	48	17	220	40.9%	57	32.5%	3.86	146	43.4%
Total		125	47	538		176		3.06	336	
APEX	LABOCA	35	18	83	36.0%	36	32.2%	2.31	40	34.4%
	SABOCA	12	7	17	7.5%	10	8.7%	1.79	10	8.4%
	SHFI	43	19	131	56.5%	66	59.1%	1.97	66	57.2%
Total		90	44	231		112		2.06	116	
ALMA	Band 3	169	12	543	30.8%	32	15.1%	16.83	N/A	N/A
	Band 6	196	17	502	28.5%	71	33.5%	7.04	N/A	N/A
	Band 7	237	30	584	33.1%	82	38.5%	7.12	N/A	N/A
	Band 9	58	10	135	7.6%	27	12.9%	4.91	N/A	N/A
Total		660	69	1764		213		8.28		

The APEX telescope on the Chajnantor Plateau. APEX, the Atacama Pathfinder Experiment, is a collaboration between the Max Planck Institute for Radio Astronomy, the Onsala Space Observatory, and the European Southern Observatory. APEX is designed to study warm and cold dust in star-forming regions both in the Milky Way and in distant galaxies.





Publication Digest

In 2012, the ESO user community published over 870 refereed papers, the highest number ever in a single year (see top right figure). This brought the total number of papers using ESO data from 1996–2012 to 9455. An overview of publication numbers can be found at http://www.eso.org/sci/libraries/telbib_pubstats_overview.html. The statistics are linked to the corresponding records in the telescope bibliography (*telbib*) database.

More than 10 000 articles from selected astronomy journals (*A&A*, *A&ARv*, *AJ*, *ApJ*, *ApJS*, *AN*, *ARA&A*, *EM&P*, *ExA*, *Icar*, *MNRAS*, *Nature*, *NewA*, *NewAR*, *PASJ*, *PASP*, *P&SS* and *Science*) were screened during 2012 in order to identify those that use data from ESO telescopes and instruments to achieve new scientific results. Approximately 8% of the papers qualified for inclusion in *telbib*.

The VLT/VLTI provided data for 614 peer-reviewed papers. This repeats the strong increase in the number of papers that could be seen in 2010 and 2011 (see top right figure) and suggests that a plateau has not yet been reached. With an average number of approximately 17%, the fraction of papers based on archival VLT/VLTI data was fairly stable during the years 2006–2011. In 2012, this number increased considerably. A quarter of the 614 papers (154 publications) used exclusively or partly (i.e., in combination with new ESO observations) data retrieved from the ESO archive. Forty percent of these archival papers (64 out of 154) were based on ESO data products (<http://archive.eso.org/cms/eso-data/eso-data-products.html>). Among them, the GOODS survey played a special role as it provided data for 36 papers (almost 24%) of all VLT/VLTI archival papers in 2012.

La Silla's research output has remained stable during the past ten years, as illustrated by the 276 papers published in 2012 based on data obtained at that observing site. This number includes only papers using data obtained at La Silla facilities for which observing time is recommended by the ESO Observing Programmes Committee (OPC); non-ESO telescopes or observations obtained during "private" periods are not included.

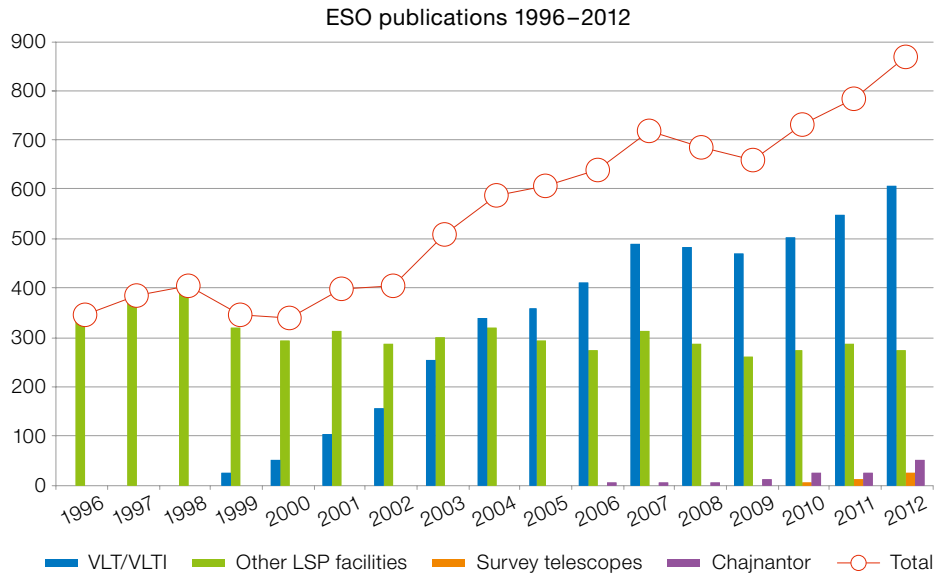

Refereed papers using ESO data, 1996–2012. Papers can use data from more than one facility. VLT/VLTI: Papers using data generated by VLT and VLTI instruments, including visitor instruments for which observing time is recommended by the ESO OPC, e.g., VLT ULTRACAM, VLTI PIONIER. Other LSP facilities: Papers using data generated by other facilities of the La Silla Paranal Observatory, including visitor instruments for which observing time is recommended by the ESO OPC, e.g., NTT ULTRACAM. Papers based on data from non-ESO

telescopes or observations obtained during "private" periods are not included. Survey telescopes: Papers using data generated by the ESO survey telescope VISTA. Chajnantor: Papers using data generated by APEX or ALMA, including visitor instruments for which observing time is recommended by the ESO OPC, e.g., P-Artemis, Z-Spec. Other visitor instruments (e.g., APEX/CONDOR) are excluded. Only papers based (entirely or partly) on ESO APEX or ALMA time are included.

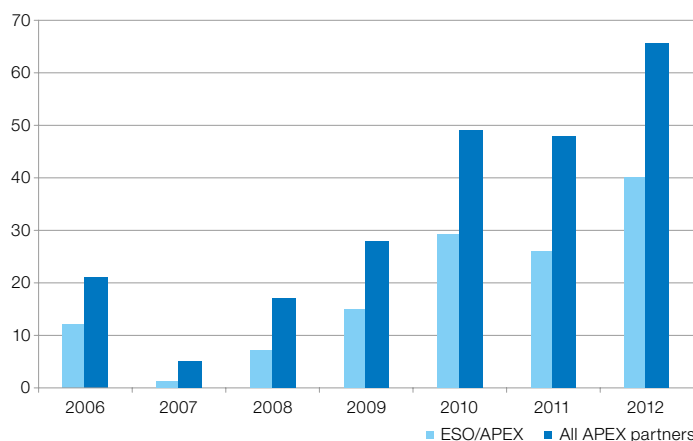

The number of papers based on ESO/APEX observations and data from all APEX partners, respectively.

ESO's survey telescope, VISTA, with its VIRCAM camera, has produced science papers based on regular observations since 2011. In the past year, 30 papers were published, mostly using data from the VVV, VIKING, VMC, UltraVISTA, VHS and VIDEO surveys.

Scientific results using data from APEX led to 66 refereed publications, including

40 papers based on ESO/APEX time. The number of papers per year using ESO/APEX data and observations provided by all APEX partners (ESO, The Max Planck Society, Onsala, Chile) are shown in the figure above.

This year, the first science results based on ALMA observations appeared, leading to a total of 19 refereed papers. The great

majority (16) involved European ALMA observing time or science verification data (13). The ALMA bibliography is maintained by the librarians at ESO and National Radio Observatory (NRAO) as well as by the National Astronomical Observatory Japan (NAOJ). For each paper using ALMA data, the programme ID(s) are recorded, along with the corresponding ALMA partner (Europe, North America, East Asia, Chile, the Joint ALMA Observatory [JAO]), observing type (standard, large, target of opportunity, director's discretionary time, science verification), and use of archival ALMA data, if any. Programme IDs in *telbib* records will be linked to the observations in the ALMA archive as soon as it becomes available.

Between 1999 and 2012, 319 papers based on ESO data were featured in ESO press releases, which translates into about 23 papers per year, or almost one every other week. *telbib* records of science papers discussed in press releases can be accessed directly from the ESO press release web pages (<http://www.eso.org/public/news/>); similarly, the public *telbib* interface provides a link to the press release page. The large majority of featured papers were published in the journal *A&A* (48.4%), followed by *Nature* (19.7%) and *ApJ/ApJS* (18.8%). The fraction of papers per journal is illustrated in the top right figure.

The statistics discussed here are extracted from the ESO telescope bibliography (*telbib*), a database of refereed papers that use observational data from ESO telescopes and instruments. *telbib* is maintained by the ESO librarians. In the course of the year, several new features have been added to the public interface (<http://telbib.eso.org>). In particular, search results can be used in a variety of ways. In addition to the export function, which allows users to create comma-separated (.csv) or tab-separated (.txt) files of the retrieved articles, it is now possible to visualise search results. Available options include a graphical view of the number of papers per instrument, year, or journal as well as the use of archival data. All graphs are interactive, i.e., information can be displayed or hidden based on the user's preferences. As an example, the bottom right figure shows the top five VLT

Papers featured in ESO press releases 1999–2012

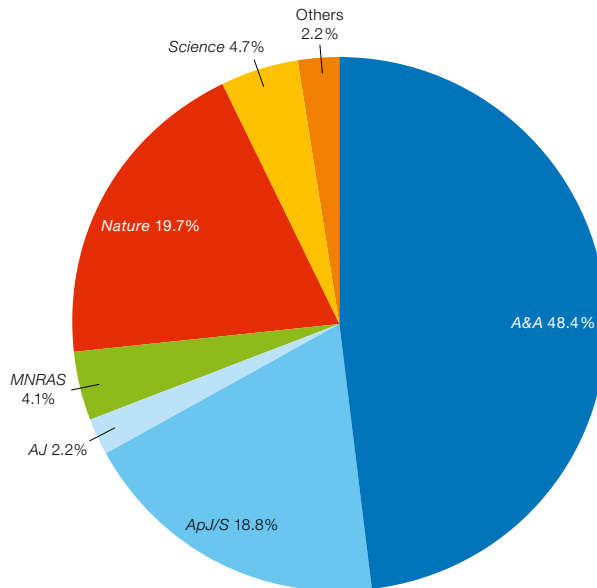

Distribution of papers featured in ESO press releases (1999-2012) by journal.

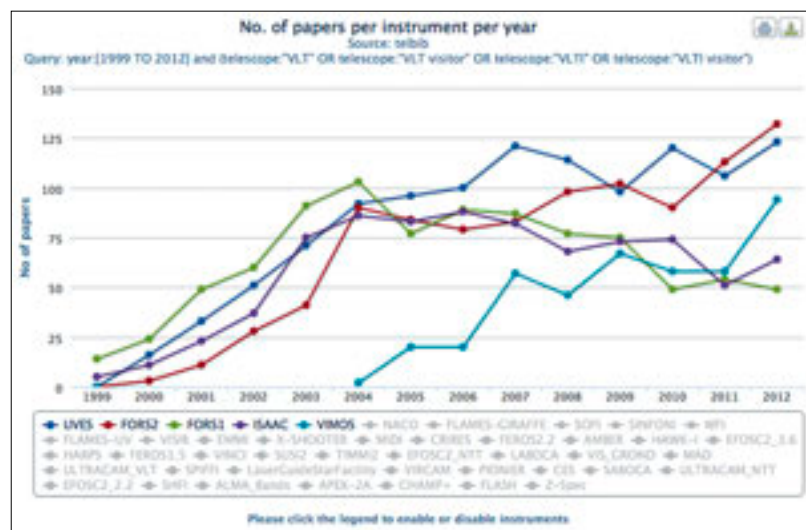

Screenshot of a visualisation of the top five VLT instruments that provided data for papers published 1999–2012, retrieved via the public *telbib* interface (<http://telbib.eso.org>). Currently greyed-out facilities can be displayed by clicking on the legend.

instruments that provided data for papers published from 1999 to 2012. Only these five instruments are visible in the graph; many others that also provided data for papers, but for a smaller number, are currently greyed out. They can be displayed should the user wish to.

The complete list of all 2012 papers can be found at http://www.eso.org/libraries/telbib_info/AR/ESO_AnnualReport_publications2012.pdf. The file includes those papers written by the ESO users' community based on ESO data, followed by a separate listing of refereed publications by ESO scientists with or without use of ESO data.

Please see the ESO libraries homepage <http://www.eso.org/sci/libraries.html> for updated summaries of publication statistics.

Operations



La Silla Paranal Observatory

The Directorate of Operations is responsible for all science operations-related activities including the preparation and execution of observing programmes, the operation of the La Silla Paranal Observatory (LPO) with its La Silla, Paranal and Chajnantor sites, and the delivery of raw and calibrated data. This involves user support, data flow management, operations technical support and the development and maintenance of a science archive as provided by the Data Management and Operations (DMO) Division. The Science Archive Facility holds all the data obtained with ESO telescopes as well as highly processed, advanced products derived from them. Included in the directorate is ESO's contribution to ALMA operations through the European ALMA Support Centre (EASC).

Highlights of Operations in 2012 have been the successful implementation of the quasi-real-time scientific data transfer from the Paranal, La Silla, APEX and ALMA Observatories to the Science Archive Facility in Garching; the successful deployment of a new generation of observation support tools for the VLT, the VLTI and the survey telescopes; the successful deployment of a Phase 3 infrastructure for advanced science data products from Public Surveys and Large Programmes in the Science Archive Facility; and the successful support of European Union (EU) ALMA projects at all stages, from their preparation, execution and quality checking through to the data delivery through the European ALMA Regional Centre and its distributed nodes.

Left: The historical image, on top, was taken around 1970 from the La Silla dormitories and looks up towards the highest point of the mountain. In the present-day photograph, some of the buildings remain, but more have been built over the decades. At the highest point is the ESO 3.6-metre telescope, which started operating in November 1976 and is still in use today. To the right of the 3.6-metre is the 3.58-metre New Technology Telescope, recognisable by the angular, metallic appearance of its enclosure.

Operations

The ESO Very Large Telescope at Paranal operates with four 8.2-metre Unit Telescopes and a suite of ten first generation instruments and the first of the second generation instruments. The Laser Guide Star Facility (LGSF) provides two of the three adaptive-optics-supported instruments of the VLT with an artificial reference star. The VLT Interferometer combines the light from either the Unit Telescopes or the Auxiliary Telescopes to feed either one of the two interferometric first generation instruments with a coherent wavefront, further stabilised by the VLTI fringe tracker, or to the VLTI visitor instrument focus. The survey telescopes VISTA and the VST are both in regular operation.

On La Silla, the New Technology Telescope, the 3.6-metre, and the 2.2-metre telescopes operate with a suite of six instruments. The La Silla site further supports seven national telescope projects.

The observatory also provides the operational support for the Atacama Pathfinder Experiment with its 12-metre submillimetre radio antenna located on the high plateau of Chajnantor at an altitude of 5000 metres above sea level and its suite of heterodyne and bolometer facility instruments, together with a number of visitor instruments.

For Observing Periods 89 and 90, the scientific community submitted 969 and 937 Phase 1 observing proposals respectively to the LPO including APEX, which documents the continued high demand at the ESO observing facilities. Some 80% of the proposals are for the Paranal site with the VLT, the VLTI, and VISTA.

The observatory continued its efficient operation through the high availability and low technical downtime of its telescopes and instruments — key elements for productive scientific observations. In 2012 a total of 2351 nights were scheduled for scientific observations with the four UTs at the VLT and with the three major telescopes at La Silla. This is equivalent to about 92% of the total number of nights theoretically available over the whole year. The remaining 8% were

scheduled for planned engineering and maintenance activities to guarantee the continuous performance of the telescopes and instruments: this includes time slots for the commissioning of new instruments and facilities. Out of the available science time for the VLT, 4.4% was lost due to technical problems and about 11% due to adverse weather conditions. On La Silla, bad weather accounted for losses of about 13% and technical problems for 2.2%. The average technical losses of the VLT are unusually high this year, but are dominated by a single but extended failure of the hydrostatic bearing system of UT4 between 18 September and 7 October. Also, the average technical losses of La Silla are higher than usual, in this case due to a damaged lateral support of the main mirror of the NTT, discovered after the re-coating of the main mirror in July. Analysis of the problem and the subsequent implementation of a remedy required 12 days, during which time the telescope could not be operated.

The VISTA survey telescope delivered 285 nights of survey observations out of 350 scheduled nights. The VST survey telescope started science operation on 15 October 2011 and delivered 268 nights of survey observations out of 349 scheduled nights in 2012.

Complementary to regular VLT operations, the VLT Interferometer was scheduled for an additional 230 nights to execute scientific observations using baselines with either the UTs or the ATs. The remaining nights of the year were used for technical activities and for further development and commissioning of the interferometer and its infrastructure. In addition to 77 engineering nights, some 58 nights were invested in the continued commissioning of the PRIMA facility designed to allow dual-star interferometry on the VLTI, 4.4% of the scheduled VLTI science time was lost due to technical problems and 18% due to bad weather.

The combination of high operational efficiency, system reliability and up-time of the La Silla and Paranal telescopes and instruments for scientific observations has again resulted in a high scientific productivity. We have counted 614 peer-

reviewed papers published in 2012 in different scientific journals, which are at least partially based on data collected with the VLT and VLTI instruments at Paranal. In addition, 30 refereed papers were published referring to observations with VISTA and the VST at Paranal, and 276 referring to ESO-operated telescopes at La Silla. Sixty-six papers were based on APEX observations, out of which 40 used observations made during the 24% share of ESO time. Since they started operations in 1999, the VLT and VLTI have produced a total of 4844 publications — more than one per day.

Scientific data transfer

While scientific publications are undoubtedly the most important final product of an observatory, another fundamental metric of productivity is the quantity of scientific data delivered. The Paranal Observatory alone produced — with the VLT, VLTI, VISTA, and the VST — 45 TB of scientific and calibration data this year. Beginning in July, all scientific data from all ESO's observatories in Chile are now transferred to the ESO Science Archive Facility in Garching via a network. Shipping of physical media such as DVDs and hard disks has been almost completely discontinued.

The bottom panel of the top right figure shows (in green) the outgoing data transfer rates from Paranal to the ESO office in Santiago using the dedicated EVALSO fibre link, which was put into full operation in March 2012. The middle panel shows the data transfer rates from the ALMA Santiago Central Office (SCO). The top panel shows the incoming traffic to the Garching Science Archive Facility, which includes, in addition to the Paranal and ALMA scientific data streams, the scientific data streams from La Silla and APEX which were added in February and July respectively. On peak days, a total of more than 450 GB of scientific data flow into the ESO Science Archive Facility in Garching.

All data files from an observing night at the LPO are transferred within 24 hours — the majority of the files within a few minutes to hours — and become immediately available to the PIs through the

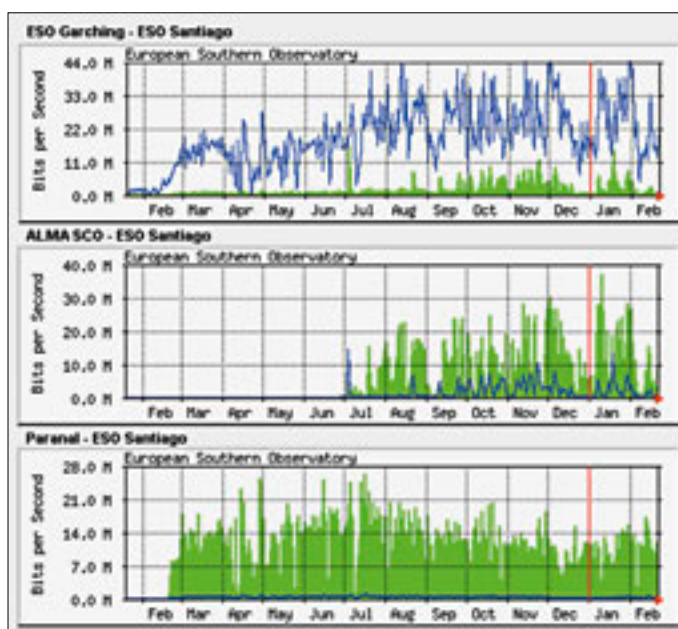

Scientific data transfer rates between February 2012 and February 2013 as daily averages (outgoing — green, incoming — blue). An average daily transfer rate of 10 Mbits/s corresponds to 105 GB of data transferred per day. The top panel shows the traffic between the ESO Santiago office and ESO Headquarters. The middle panel shows the traffic between the ALMA Santiago Central Office and the ESO Santiago office. The lower panel shows the traffic between Paranal and the ESO Santiago office.

Science Archive Facility in Garching (for the latest developments in the Science Archive Facility see the DMO section below). Not only the astronomers in the community can take advantage of the fast scientific data transfer for their research, but the observatories can obtain quasi-real-time feedback on the quality of the delivered data from the Quality Control group in Garching. This group processes and analyses the scientific and calibration data with a particular focus on data quality, data completeness and the health of the scientific instruments that produced them.

Paranal Observatory

Instrumentation and infrastructure

The observatory is eagerly awaiting the arrival of the second generation VLT instruments KMOS, SPHERE and MUSE. In preparation for these new, complex and also large facility instruments, Paranal has built and prepared a new dedicated instrument integration hall next to the mechanical workshop building at the basecamp. The integration hall comprises three areas: a main hall consisting of a Class 100 000 cleanroom 135 m² in area, 45 m² of office space, and a 60 m² (dirty) entrance and unloading area. The hall and the entrance area are each equipped with a 10-tonne crane with a

clearance of 5.25 metres between floor and crane hook. The clean area can be sealed with a hermetically sealing roller door to avoid contamination. The integration hall has all the necessary infrastructure and is large enough to host two large instruments at the same time. A clean air conditioning system keeps the humidity at 40–45%. The illumination is low energy consumption and the floor lining is conductive. There are four standard service connection points available. These allow up to three 10 kW closed-cycle coolers to be connected, and for a connection to a 40 kW uninterruptable power supply and to a compressed air and cooled media supply to be made. There is a local area network available for the instrument control and connection to the public network at the basecamp. The outfitting of the new integration hall is well adapted to the new and more stringent requirements for the assembly, integration and verification phase of the instruments to come. KMOS was the first instrument to arrive at Paranal and took advantage of this new facility for several months before it was moved to UT1 in November for commissioning.

Another major activity for an upcoming new facility carried out this year was an infrastructure upgrade of UT4 for the Adaptive Optics Facility (AOF). In preparation for the future installation of the Four



UT4 during the telescope infrastructure upgrade for the AOF in March and April.

Laser Guide Star Facility (4LGSF) and the deformable secondary mirror on UT4, the telescope and its infrastructure had to be adapted to their new requirements. For the cooling, power, and network supplies, this included the re-routing of the existing systems, and the installation of additional capabilities on the telescope and its infrastructure. This intensive work was organised around a planned main mirror re-coating for UT4 in March and extended over a total of six weeks. The figure above shows UT4 hidden behind the scaffolding necessary to access the telescope centrepiece and the telescope top ring structure, once the main mirror cell and the main mirror itself had been transferred to the coating facilities in the

Paranal basecamp. The telescope came back into operation as planned in early May.

Shortly after KMOS had left the new integration hall in November, it was occupied again by the next project: PARLA, the new laser source for the Laser Guide Star Facility at UT4. It will replace the original PARSEC laser after six years of operation and is expected to greatly improve the reliability and the flexibility when operating the LGSF with the NACO and SINFONI adaptive optics instruments. It takes advantage of the new solid-state Raman fibre laser technology that will also be employed in the 4LGSF of the AOF. The new laser source delivers up to

20 W of continuous output power and is very stable. It will be operated in a reduced power mode and is expected to propagate up to 7 W of laser power into Paranal's sky. Installation at UT4 will start in early 2013. The laser will then be used to generate an artificial star about 90 kilometres up in the atmosphere. By creating and observing such a bright point of light astronomers can probe the turbulence in the layers of the atmosphere above the telescope. This information is then used to adjust deformable mirrors in real time in order to correct most of the distortions caused by the constant movement of atmosphere and to create diffraction-limited images.

Science operations

After 13 years of successful operation of the Paranal Observatory, this year has seen an evolution towards a revised science operations plan for Paranal, which has been dubbed SciOps 2.0. The content of this updated plan is based on a re-organisation of the science operations staff tasks, primarily in order to improve the efficiency of the core science operations support to service mode (SM) and visitor mode (VM) observations and the quality of the astronomical data delivered to the community of Paranal users. The plan further strengthens the coordination of science operations activities within and between the department groups by increasing the time allocated to high-level activities, i.e., activities typically related to instrument operation and general operational processes. In a nutshell, the operational changes are articulated along two main lines: first the adoption of a classical shift-scheduling scheme for some (three out of five) of the night-time support astronomers, whose duty time is shifted from sunset–sunrise to 15:00 – 02:00–04:00; and second, the replacement of one daytime support astronomer by an operations specialist. The operations specialist is a new job profile at the observatory and the first operations specialist has been recruited from among the pool of senior telescope and instrument operators. These two modifications allow the recovery of some operations time, which can then be re-injected into high-level astronomers' tasks. Finally, the new job profile of operations specialist permits the widening of the scope for qualified science operations staff members who can now support both day- and night- time core operational tasks.

One prerequisite for the successful integration of non-astronomers into the night-time science operation was the availability of a new generation of operation support tools, in particular of the central Observing Tool which has been equipped with novel condition-based quasi-automatic short-term scheduling capabilities. These new capabilities are spin-offs from earlier developments, which have been undertaken for the Paranal survey telescopes VISTA and the VST. These two survey telescopes have been operated from day one in a quasi-automatic queue mode by a single

telescope and instrument operator without the presence of a support astronomer. The fundamental scheduling algorithm is simple but efficient: “always go for the most difficult observation which is just compatible with the constraints set by the user and the atmosphere”. The extension of the short-term scheduler from the survey telescopes to the VLT and the VLTI was carefully tested over six months on UT2 before introducing the tools at the other UTs and the VLTI. After full deployment in October, the gradual implementation of the SciOps 2.0 operations plan has started with the goal of full implementation by mid-2013. Sophisticated performance metrics have been put in place to measure the success of the implementation and eventually to document the improved efficiency of science operations at Paranal.

Engineering and maintenance operation

The engineering and maintenance strategy for Paranal Observatory aims at providing the best possible technical support to the scientific operation of the observatory. Consequently it targets the highest possible availability and reliability of all operation-critical systems, builds on their certification and warranties and, at the same time, provides a quick response to problems encountered, while always keeping an eye on a possible rationalisation of the operation.

At Paranal Observatory, this is a shared and continuous effort of the Engineering and Maintenance departments, supported by a rational level of outsourcing. Dedicated engineering projects intended to keep the observatory at the forefront of research are carried out following the same philosophy. While ESO staff concentrate on core business activities like the maintenance of telescope systems, scientific instruments and other critical equipment, and the critical technical operations like re-coating of the mirrors and calibration of instruments, the external maintenance partners have responsibility for the execution of work packages at the non-critical and low-complexity level of telescope and facility operation. The contractor work packages are defined through specific statements of work and provided and controlled according to a service-level agreement.

Additional work packages specify the technical support to be provided by the contractor to the technical operation and engineering and other projects of the observatory. The third pillar of the observatory's engineering and maintenance strategy is the utilisation of external companies that represent the original equipment manufacturers (OEM) of commercial off-the-shelf equipment used at the observatory, such as all air-conditioning systems, compressors, generators, and also the multi-fuel turbine power generator. The technical representatives of OEM equipment have highly specialised expertise relevant to the equipment they support and are able to provide equipment certifications and warranties, eventually leading to the highest availability and reliability at lowest cost.

During this year the Paranal Observatory has made major progress in the implementation of its engineering and maintenance strategy through a novel and fully service-level agreement-based engineering and maintenance support contract with MT Mecatronica Ltda., the Chilean subsidiary of MT Aerospace AG (Germany). In parallel, the network of external companies providing OEM support to the observatory has been expanded and strengthened. The implementation of this Paranal engineering and maintenance strategy in a timely fashion is considered a crucial step towards the anticipated future capability of Paranal to operate and support the VLT and the E-ELT as one observatory.

La Silla Observatory

La Silla Observatory continues to operate successfully according to the streamlined operations model. This La Silla 2010+ model supports the continued operations of the three major telescopes and their instrumentation, i.e., the 3.6-metre telescope with HARPS, the NTT with SOFI, EFOSC2 and visitor instruments, and the 2.2-metre telescope with FEROS and the Wide Field Imager (WFI). The 2.2-metre telescope operates according to an agreement with the Max Planck Institute for Astronomy (Heidelberg, Germany). This agreement ensures the continued operation of the 2.2-metre telescope until 2013, with an ESO share of 25% of the

available observing time. This is in response to continued requests by the community for the FEROS and WFI instruments. The La Silla Observatory also continues to support scientific projects at the Danish 1.54-metre telescope, the Swiss 1.2-metre Leonhard Euler Telescope, the Rapid Eye Mount telescopes, the TAROT, the ESO 1-metre Schmidt telescope and the TRAPPIST telescope.

The ESO 1-metre telescope was prepared during the first half of the year to resume operation under an agreement between ESO and Católica del Norte University (UCN; Antofagasta, Chile). The astronomical institute of UCN plans to upgrade the telescope to allow remote operation and to install new instrumentation to carry out a three-year research programme on the multiplicity of stars as a function of stellar mass, and on active galactic nuclei (AGN) black hole masses.

The Niels Bohr Institute (Copenhagen University, Denmark) and the Astronomical Institute Ondřejov represented by the Academy of Science of the Czech Republic have signed an agreement to jointly refurbish and operate the Danish 1.54-metre telescope at La Silla until the end of 2014. The refurbishment of the telescope, its infrastructure and control system, and also the the Danish Faint Object Spectrograph and Camera (DFOSC) was efficiently carried out under the leadership of the Czech company ProjectSoft HK during the year. The telescope can now be fully operated remotely from the Czech Republic and Denmark and has started carrying out the Danish MiNDSTeP project, whose main goal is to monitor ongoing microlensing events with high photometric precision, and the Czech NEOSource project to obtain high-precision photometry of asteroids.

APEX

The Atacama Pathfinder Experiment (APEX) continued to operate its 12-metre antenna with its suite of heterodyne and bolometer facility instruments and visitor instruments in a quasi-continuous 24-hour operation mode. This maximises the exploitation of the exceptional conditions available at the site of Chajnantor at an altitude of 5000 metres above sea

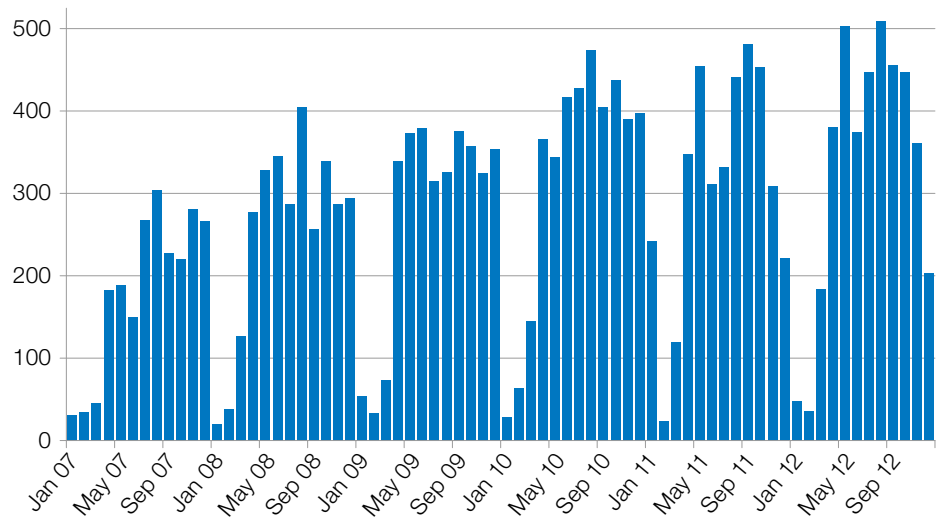

APEX monthly on-sky time over the last six years of science operation. Up to 500 hours per month have been made available for science observations in 2012. Although APEX does not generally operate

between 21 December and 20 March due to adverse weather conditions caused by the altiplanic winter, a small number of observations are, however, possible.

level. A total of 252 days and nights were scheduled for science observations with APEX, out of which 212 could actually be used, resulting in a total of 3942 hours of on-sky science time. This corresponds to an 80% increase of the on-sky time compared to the year of 2007, showing that APEX has reached operational maturity at a high level of observing efficiency. More than 500 hours per month of on-sky time were made available for science observations in both May and August (see the figure above).

The APEX project is a partnership between the Max Planck Institute for Radio Astronomy (MPIfR, Bonn, Germany, 50% share), ESO (27% share) and the Onsala Space Observatory (OSO, Sweden, 23% share), originally foreseen to terminate after six years of science operation, i.e. by the end of 2012. However, considering the success of the project, all APEX partners have expressed their wish to continue the project to extract the maximum scientific benefit from this unique facility. Therefore, the APEX operation agreement has been extended to 31 December 2015 with unchanged shares of observing time.

As a consequence of the extension of the lifetime of the project, new investments in the antenna and the infrastructure are required to overcome obsolete hardware

and an aging infrastructure at the high site of Chajnantor and at the basecamp in Sequitor near San Pedro de Atacama. Therefore, the APEX partners have agreed to a re-investment plan. In 2012 reinvestments were made in the areas of the computing infrastructure, critical spare parts, e.g., for the wobbler, and an upgrade of the chiller compressor.

The agreement between the APEX partners makes provision for a further extension until 2017 conditional on the evaluation of the scientific competitiveness of APEX in the coming years. This will be reviewed in early 2013 by an external review of the project. The competitiveness of APEX in the era of a fully operational ALMA will depend strongly on its survey capabilities and therefore on the results of the ongoing receiver developments by the APEX partners, in particular in the area of large-sized cameras with several thousands of detector elements.



These images symbolise how the computing power used by ESO has increased dramatically with time. Both photographs show Austrian astronomer Rudi Albrecht in front of ESO's computer systems, but on dates separated by decades. The historical image was taken in 1974 in the ESO offices in Santiago, Chile. The present-day photograph was taken in the Data Centre at ESO Headquarters in Garching bei München in Germany, in front of a rack containing a system over five million times more powerful than the machine he was using back in 1974.



Data Management and Operations Division

The Data Management and Operations Division provides user support and operates and guides the development of the data flow system for the La Silla Paranal Observatory and ALMA (for the European community). The concepts of VLT end-to-end operations form the basis of the science operations model proposed for the E-ELT as part of its construction proposal. This defines directions for the further development of operations on Paranal, and of the infrastructures that support them, over the coming years.

User Support Department

The User Support Department (USD) completed two major and important upgrades of the main tools necessary for the preparation, support and execution of observations: a new ticketing system plus a significant upgrade of the Phase 2 Proposal Preparation (P2PP) tool and the Observing Tool (OT).

The new cross-departmental Remedy-based ticketing system (aka PROP, Portal for Reporting of Operational Problematics) went live in March 2012. This new deployment was fully transparent to the users, who now benefit from also being able to contact us via a web form with pre-defined options, which help to identify the issues more readily. The major advantage of this new portal is mostly for ESO Operations, since all operationally linked groups/departments are now gathered in one place and are able to share information.

For version 3 of P2PP and the OT, the USD, in close collaboration with Paranal Science Operations, evaluated in detail the complexities brought to the system by 13 additional VLT/I instruments. Both of these tools had already been deployed at VISTA and the VST from the very start of the Public Surveys. A robust ranking algorithm was implemented in the upgraded OT to take advantage of the new features included in the P2PP v.3 tool. Users now have the possibility to link time-critical Observation Blocks (OBs), to concatenate those observations that need to be carried out back-to-back (e.g., science + calibration) and to group the OBs of a given programme that

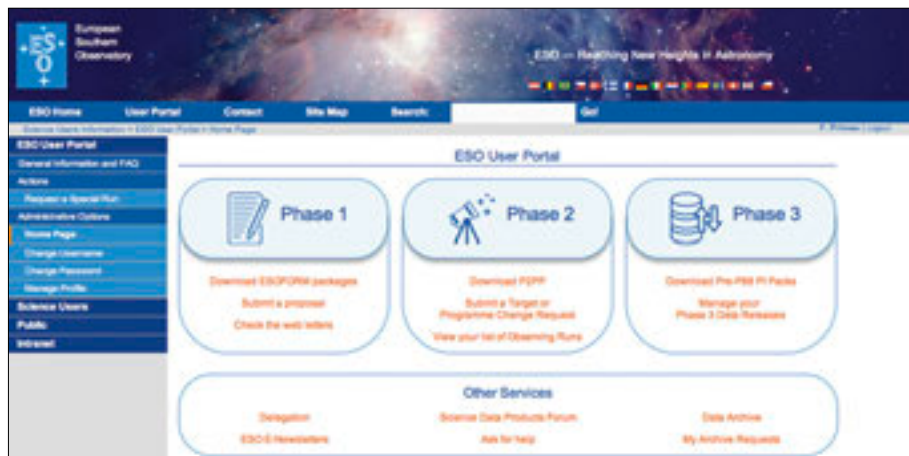

The newly re-styled homepage of the user portal, which is easier to navigate once logged in.

would benefit from being executed first, before moving on to a different set of observations (e.g., imaging OBs sharing the same filter in a multi-band programme).

Because of the additional complexity, the upgraded tools were first deployed at the Kueyen Telescope (UT2) in March/April and then at all other telescopes in September/October. This deployment was accompanied by the release of other enhancements to our operational interfaces. First, the new tools now allow service mode PIs to delegate their Phase 2 tasks to somebody else; a feature long-awaited by our users' community — 20% of all Period 90 SM PIs have already taken advantage of this new feature. Secondly, the installation of a new night log tool on Paranal made it possible to re-style the progress report pages that USD offers to its SM users. These are now directly extracted from the night reports and include information about the quality of the executed observations. This facelift culminated in December with the launch of a new email subscription service to night reports for Paranal SM PIs and/or their Phase 2 delegates. In short, users can now be notified every time one of their observations has been executed. The USD also organised two Phase 2 Users' Workshops at ESO Headquarters in Garching (January and July), presenting the new tools and providing face-to-face support to the users.

European ALMA Regional Centre

With the start of Early Science observations in September 2011, the 2012 European ALMA Regional Centre (ARC) concentrated on following the European PI projects from their preparation, execution and quality checking through to data delivery. In addition to this, face-to-face support has commenced. This is one of the core functions of the ALMA project provided by the ARC nodes throughout Europe. The support includes help with proposal preparation, data reduction and, soon, archival research. A face-to-face visit can be arranged through the ALMA Helpdesk. To date, 23 requests for face-to-face support have been recorded by the Helpdesk, 18 of which asked for support for data reduction of Cycle 0 projects and the remaining five for Cycle 1 proposal preparation. In addition to these formal requests, face-to-face support is being regularly provided to scientists from institutes hosting the ARC nodes or to users coming from neighbouring institutes.

PIs or Co-Investigators requesting support are assigned to an ARC node based on their geographical location or possible collaborations, and to a specific ARC node person who will help them for the duration of their visit. Some ARC nodes have dedicated funding to support these visits, other users obtain funding from their home institutes. RadioNet3 MARCUs (Mobility for ARC Users) network funding

is also available for users who do not have access to a local ARC node, or who have scheduled a face-to-face visit to a node other than their local node.

At the end of their visit, all users are requested to fill out a face-to-face visit feedback form, in order to capture the user experience. Observers who visit an ARC node for the purpose of data reduction usually grant access to their data to the ARC node prior to the visit in order to speed up the process. About a third of the users reported that the data reduction carried out during their visit was sufficient to achieve their scientific goals, while another third were planning some additional reduction steps after they returned to their home institutes. The remaining 30% did not provide any relevant feedback. The visitors graded themselves in equal numbers as novice, intermediate or expert in their interferometric data reduction skills and, in their large majority, ranked the ARC staff assigned to them as very competent and friendly, providing very positive feedback on the interaction.

Relevant output was also captured by the second ALMA user satisfaction survey carried out in September among all registered ALMA users. The survey showed that 93% of those who answered the relevant parts of the survey characterised the quality of the face-to-face support as above average.

APEX activities at the ARC department have been carried out as usual by the APEX group. The group supported the last observing run of the Z-spec visitor instrument, which provides an important synergy with ALMA. Some first results were submitted in combination with ALMA Cycle 0 data. In 2012, the APEX project moved to a network-based transfer of the new APEX science data to the PIs, reducing the delay in data access from a few months to a few days, thereby allowing the users to provide input for ongoing observations.

Data products

The Data Processing and Quality Control group works closely with the Paranal Science Operations department to assure that all instruments always perform within

the expected and published ranges. Taking advantage of the fast data transfer link, the quality control loop between Paranal and Garching is routinely closed on a timescale of about one hour. During 2012 the group processed about 8 TB of VLT/VLTI raw data in 180 000 processing jobs. The creation and distribution of these products was discontinued in October 2011 in favour of self-service access through the ESO Science Archive Facility (see below). In addition, close to 25 TB of data from the survey telescopes VISTA and the VST were processed to monitor the instruments' performance and data quality. This is more than three times as much as the entire suite of the other 14 VLT/I instruments on Paranal.

In accordance with ESO policy, advanced science data products from Public Surveys and Large Programmes are being returned to the Science Archive Facility by their respective PIs for the community at large to exploit. The Archive Science group has developed, in close collaboration with the Software Development Division, a set of standardised procedures and tools to streamline this process, dubbed Phase 3 by analogy with the submission of observing proposals (Phase 1) and the specification of the detailed observing strategies (Phase 2). In the course of 2012, the Phase 3 infrastructure was extended to include the handling and publication of source catalogues which are, arguably, the ultimate data product from Public Surveys. Archive users are now able to browse the content of the catalogues for a number of scientific criteria in order to identify and download the entries of interest. Interactions with the survey teams proceed on a regular basis to ensure smooth Phase 3 operations and the continuing growth of the archive content of data products.

ESO's efforts to improve the scientific quality of the data products, a task coordinated by the Science Data Products group, continued this year with the final major public release of Reflex, again the outcome of close collaboration with the Software Development Division. Reflex is a software platform that runs ESO data reduction modules in a user-friendly way. The data reduction cascade is rendered graphically in the form of a scientific workflow, where each box corresponds

to a step in the process and data flows seamlessly from one box to the next. In addition to the capability to run the data reduction modules, Reflex provides, amongst other things, the capability to organise and associate the input data, as well as the capability to insert custom tools written in popular languages (currently python). This new release adds features guided by feedback from previous versions and marks the end of the main development of the infrastructure. From this point on, the effort will be largely focussed towards enhancing the quality of the data products from selected instruments. In this respect, the year saw the release of a greatly improved pipeline and calibration plan for the reduction of X-shooter echelle data. This is one of the most popular instrument modes on the VLT, based on the experience from the first years of regular science operations. Reflex now supports the following instrument modes: UVES, X-shooter echelle, FORS spectroscopy and VIMOS integral field units (IFUs; these four instruments account for about 50% of the time scheduled at the VLT). The first two are interactive and fully scientific workflows, while the latter two are more basic and, with limited interactive capabilities, are intended to facilitate the data reduction process. Work is in progress towards a full scientific validation of the FORS and VIMOS spectroscopic pipelines, together with the upgrade of the respective Reflex workflows to full interactivity.

Science Archive Facility

The Science Archive Facility is now the only distribution point for all ESO data. This includes access to proprietary data for both visitor and service mode runs, which is limited to the corresponding Principal Investigators and their authorised delegates for the duration of the proprietary period (typically one year). On average, the files become available from the Science Archive Facility within a few hours of the observation. The archive calibration selector service allows the association of calibrations and ancillary files to raw science files for further processing. The new design of the homepage of the Science Archive Facility gives easy access to the different data collections hosted there.

Welcome to the ESO Science Archive Facility

The ESO Science Archive Facility contains data from ESO telescopes at La Silla Paranal Observatory, including the APEX submillimeter telescope on Llano de Chajnantor. In addition, the raw UKIDSS/VISCAAM data obtained at the UK Infrared Telescope Facility in Hawaii are available.

The Principal Investigators of successful proposals for time on ESO telescopes have exclusive access to their scientific data for the duration of a proprietary period, normally of one year, after which the data becomes available to the community at large. Please read the [ESO Data Access Policy](#) statement for more information, along with the [relevant FAQs](#).

Browsing the archive does not require authentication, but to request and download data you have to log in to the [ESO User Portal](#). Please [acknowledge the use of archive data](#) in any publication.

Latest News and Updates

- OSB Batch Your patch available (27 Feb 2013)
- Phase 3 data format standard for OmegaCAM data available (17 Jan 2013)
- New Public Survey Catalogue (Ultra-VISTA) available through the ESO Science Archive Facility (25 Dec 2012)

More news ...

To browse the archive

Currently, raw data and various types of data products can be reached via different interfaces:

Category	Query Forms	Data collection	Data Type	Instruments
LPO Raw Data	Raw data query form (all instruments) Instrument specific query forms Direct retrieval of raw data by file name	All ESO raw data	Various	Many La Silla Paranal instruments
LPO Data Products	Phase 3 main query form Phase 3 imaging query form Phase 3 instrument specific query form	Phase 3 Data Products (ESO Public Surveys)	Currently, Imaging	Currently, VISTA/VIRCAM
	Catalogue Facility query interface	Phase 3 Catalogues (ESO User Portal authentication required also when browsing)	Catalogues	Currently, VISTA/VIRCAM
Advanced Data Products query form		GOODS (C. Cesari et al.)	Imaging, Spectroscopy	FORIS/ISAAC/VIMOS
		JCOSMOS (S. Lilly)	Spectroscopy	VIMOS
		Observation of Cool astrometrically-selected HD stars (E. Poretti)	Spectroscopy (line series)	FEROS
		UNES reprocessed	Spectroscopy	UNES
FEROS/HARPS pipeline processed data query form		Time-domain survey of NGC 2547 (S. Adrian)	Imaging	FEROS
		FEROS/HARPS pipeline processed data	Spectroscopy	FEROS, HARPS
Science Verification, Commissioning, EIS, etc.		Full list of available data packages	Various	Many
APEX Query Products	APEX query form	APEX	Heterodyne, Bolometer	APEX-2A, LABOCA, SABOCA, SHARP
ALMA Data Products	ALMA Science Verification	All ALMA SV data	Cube	ALMA

The ESO Science Archive Facility was developed in partnership with the [Spain Telescope - European Coordinating Facility \(ST-ECF\)](#). It was operated jointly until the [acquisition of the ST-ECF](#) in December 2010.

Following the addition of 50 TB of new data this year, the total archive holdings approach the 300 TB mark. Close to 37 000 archive data requests were made during the year, triggered by queries posted on the archive main query and instrument-specific query pages. These correspond to the activities of more than 2000 unique archive users. The total number of files served through the ESO Science Archive Facility approached eight million.

Major new releases of data products include images and catalogues from Public Surveys on the VISTA telescope. The first releases of data products from Public Surveys on the VST, as well as of Spectroscopic Public Surveys on the NTT and VLT/FLAMES, are due in 2013.

The Science Archive Facility remained a strong contributor to ESO's scientific output as measured by the number of refereed publications. In fact, almost a quarter of the refereed papers from VLT/I published during the year used exclusively or partly (i.e., in combination with new ESO observations) data retrieved from the ESO archive (more details in the Publication Digest section of this report).

The re-vamped homepage of the ESO Science Archive Facility provides easy access to the different data collections hosted there.

By agreement with the European Space Agency (ESA), the European copy of the Hubble Space Telescope archive was

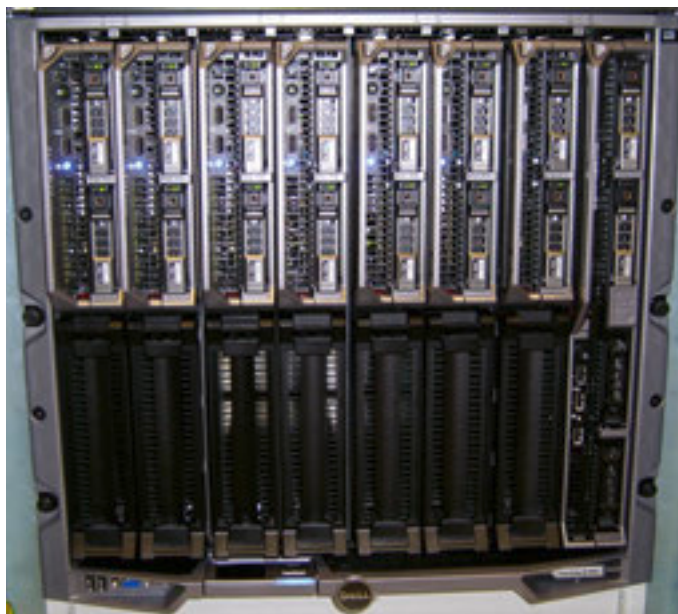

The old and new data-processing hardware for the Paranal data stream (left and right picture, respectively). The old one consisted of over 30 blades in a blade centre, while the new one is based on a blade chassis with only eight multicore servers. This replacement will dramatically reduce the data centre footprint, saving power, cooling and overall maintenance costs, while ensuring state-of-the-art performance to meet the challenges of handling a complex data stream.

transferred from the ESO Headquarters to ESA's European Space Astronomy Centre in Spain, from where it continues its operations.

Operations Technical Support

The Operations Technical Support Department operates the ESO Data Centre, maintains the operational and service-specific computer systems, manages mission-critical database servers

and provides operational web support as well as administration and development for an operational problem reporting system in support of the ESO data flow.

The department was instrumental in providing support to ESO's science operations. Major milestones this year included the installation of the European ALMA Regional Centre computer cluster; the extension of the capacity of the Oracle relational database management system; the deployment of the ALMA archive

request handler; the replacement of the data-processing hardware for the Paranal data stream and the deployment of PROP.

Operations Technical Support has been the driving force behind a standard hardware environment at ESO. This agreed hardware environment, spanning all information technology (IT) areas, will simplify the system management activities.



Correlator technician Juan Carlos Gatica with one of the most powerful supercomputers in the world, installed at ALMA AOS at 5000 metres above sea level, high in the Chilean Andes.

ALMA (ESO/NAOJ/NRAO); C. Padilla

European ALMA Support Centre

The European ALMA Support Centre, formally instituted at ESO on 1 October 2009, ramped up staff and activities during the year as ALMA moved further into early operations in parallel with construction. EASC has developed into the face of ALMA for the European scientific community and the international ALMA partners for ALMA operations. EASC is an important component for the success of ALMA, both for its performance as a scientific instrument and for ESO as a partner in the ALMA project.

EASC responsibility comprises the roles of ALMA Regional Centre operations, ALMA offsite technical maintenance and development support, ALMA science and outreach. The high-level scientific representation and scientific guidance of the European ALMA project will continue to be provided in the operations phase by the European Programme Scientist, who acts in close collaboration with the VLT and E-ELT Programme Scientists to exploit the scientific synergies with ESO's other major programmes.

For the scientific user community, the central ARC at ESO Garching and the ARC nodes in Europe are the primary interfaces to the individual ALMA users. The share of core and additional functions between the central ARC and the ARC nodes is detailed in the ARC node implementation plan. This year the ARC and the ARC nodes were shown to be crucial in providing the users in ESO Member States with high quality data from ALMA Early Science Cycle 0. The European model of distributed ARC nodes has proven very efficient in serving the users' community. In parallel, preparations for Early Science Cycle 1, scheduled to start in early 2013, were carried out.

The ALMA partnership foresees continuous upgrades and the development of new software, front ends (e.g., additional receiver bands) and other hardware or system capabilities during the operations phase. The interface at ESO for the technical community in Europe is the EASC's ALMA Technical Support group. This year the first ALMA upgrade and development project, equipping the full array with Band 5 receivers, has been approved by all relevant advisory and

decision-making bodies of ALMA and ESO. The process was governed by the ALMA development plan principles, which were agreed between the ALMA partners in 2011. The basic principle is to establish one coherent ALMA development programme across the three ALMA partner regions, with each partner managing the approved development projects according to their own rules and traditions (which ESO does for Band 5). With respect to the development programme, the role of EASC is to ensure and enable high quality proposals from the European instrumentation community, coordinate and manage the programme and development projects in Europe, as well as represent Europe in the international ALMA collaboration.

Following the very successful first call for studies for ALMA upgrades and developments in Europe in 2010, EASC prepared the second call this year, to be issued in 2013. The primary aims have not changed: give European groups the opportunity to propose ALMA upgrades that may later be implemented as part of the ALMA Development Plan; support the development of conceptual and detailed designs for ALMA upgrades; and encourage relevant long-term research and development. During this year, several of the supported studies were completed (preparations for ALMA Band 5 full production; Band 9 upgrade options; implications and cost for the system doubling the IF [intermediate frequency] bandwidth for the back ends) while others are ongoing (phasing ALMA for (sub-)millimetre very long baseline interferometry (VLBI) observations; supra-THz interferometry with ALMA; components and the science case for ALMA Band 2).

Outreach and media presentation of ALMA and its achievements are provided by the ESO education and Public Outreach Department (ePOD), in coordination with the outreach department of JAO and those of the other ALMA partners.

A European antenna at the ALMA Array Operations Site.





Programmes



Instrumentation for the La Silla Paranal Observatory

The year 2012 will go on record as one of the most significant in ESO's 50-year history, with the approval of the E-ELT as a new supplementary programme by the ESO Council in December. This decision lays the foundation for the project to move forwards into full construction. On ALMA, major breakthroughs were achieved in the areas of antenna acceptance and integration of the front ends, capitalising on the considerable hard work expended to bring these key ESO deliverables into a smooth and rapid delivery process. In terms of instrumentation, the first light of KMOS marked a high point in the delivery of second generation instruments for the VLT. The integration and first commissioning on sky of this complex cryogenic instrument went extremely smoothly and is a testament to the hard work, professionalism and careful planning of all involved.

KMOS commissioning

The formal period of testing and verification of KMOS began this year, proceeding from laboratory tests to on-sky commissioning. Initially, engineers and scientists from ESO in Garching and in Chile worked with the consortium at the UK Astronomy Technology Centre to verify the instrument. This work culminated in KMOS passing Provisional Acceptance in Europe (PAE), which formally authorises delivery to the observatory. KMOS was delivered in two consignments: the instrument itself travelled by air, but the large cable rotator could only be sent by ship. Both arrived in Antofagasta at the end of August. The instrument was reassembled and tested in the integration hall on Paranal to check that no damage had resulted from the transport. Installation on the telescope's Nasmyth platform followed. Thanks to the high level of preparation from the consortium and ESO engineers on Paranal, the schedule for the integration held to within one day and lasted just over one month.

In November, the instrument was cooled to its operating temperature of 115 K to start the commissioning. First light on sky was achieved on 21 November. At first just a single star was acquired within the field of view of one of the 24 KMOS IFUs.

This meant that all the telescope and instrument systems, working together for the first time, were able to position the star to within 2 millimetres. The use of KMOS was quickly expanded to working with all 24 IFUs simultaneously and then to testing scientific targets. KMOS is designed with observations of multiple galaxies in clusters in mind in order to meet one of the main scientific goals of the instrument — namely studying the mass assembly of galaxies as a function of redshift. Some representative targets for this science case were observed, showing that the dynamics of these systems could be measured as expected. As well as observing 24 single, well-separated targets, KMOS can also map larger areas of the sky. This mode was tested on observations of nearby galaxies and even of the planet Jupiter. This really demonstrates the versatility of the new spectrograph. Further periods of testing are planned in 2013 before the instrument is offered to the astronomical community.

KMOS is the silver structure at the centre, surrounded by the blue ring structure that connects it to the VLT Unit Telescope 1, appearing on the left. On the right the large silver cylinder supports the extensive KMOS electronics and allows them to rotate as the telescope moves across the sky.



Left: The historical image, on top, taken in mid-to-late 2004, shows the VISTA building under construction. The present-day picture shows the telescope after its completion.

ESO/G. Lombardi (gphoto.it)

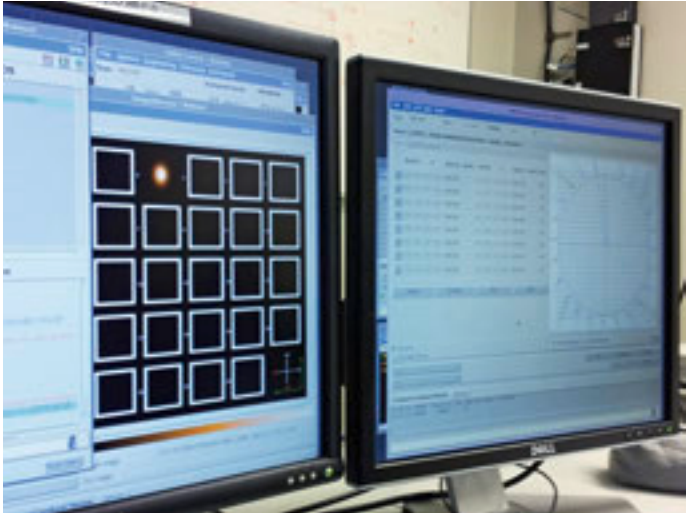

This picture shows first light with the KMOS multi-IFU spectrograph on the VLT. The target star appeared perfectly at the position expected as shown on the monitor.

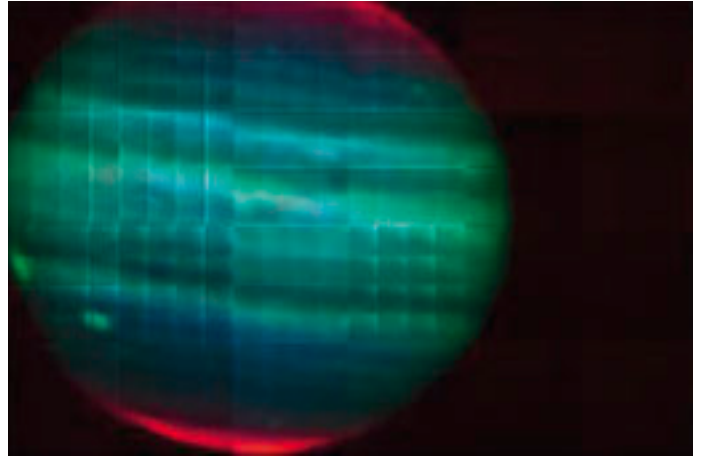

This picture of Jupiter was taken by multiple exposures using the 24 KMOS arms to obtain a single giant IFU datacube. Each point in the image is a spectrum and the entire picture contains more than 35 000 spectra. A quick selection of the wavelengths to include in the image reveals the auroral glow at Jupiter's poles.

Instruments approved or under construction

The IFU spectrograph MUSE (PI: Bacon, Lyon) continued into its final integration phase. When commissioned, the instrument will provide a huge 1×1 -arcminute field of view, with each 0.2-arcsecond pixel giving a complete spectrum, with 90 000 spectra obtained in a single shot. Unfortunately, problems were discovered with the manufactured field-splitting optics unit, which required a new unit to be procured. This had the effect of slowing progress and so commissioning will be delayed until late 2013. Nonetheless the end-to-end verification of three MUSE channels was successfully accomplished in the laboratory during the year.

Following the assembly readiness reviews of the individual instruments and subsystems, this was the year for putting SPHERE (PI: Beuzit, Institute of Planetology and Astrophysics of Grenoble [IPAG]) — ESO's planet-finder instrument — together in Grenoble. The last system to be integrated was the SAXO extreme adaptive optics (XAO) system in March. Since then, SPHERE has been tested fully integrated, operating through templates and using data reduction recipes to obtain results. Despite some problems with the high-order deformable mirror, SAXO delivers a very good image

quality with Strehl ratios reaching 90% in the *H*-band in good (0.65-arcsecond) simulated seeing. In September, a thermal tent was installed around SPHERE, and the complete instrument was operated at temperatures between 5 and 20° Celsius to confirm the specified operating environment. SPHERE is currently undergoing PAE testing and shipment is planned for summer 2013, followed by installation at the VLT and first light in the late northern autumn.

The ESPRESSO ultra-stable high-resolution optical spectrograph (PI: Pepe, Geneva) progressed on schedule, entering its final design phase and advancing in the final design of all major components such as the coude train and spectrograph. There was continuing progress in the detailed design of all instrument subsystems. ESPRESSO has major interfaces with the VLT that have required considerable work in order to use the combined focus as a way of achieving

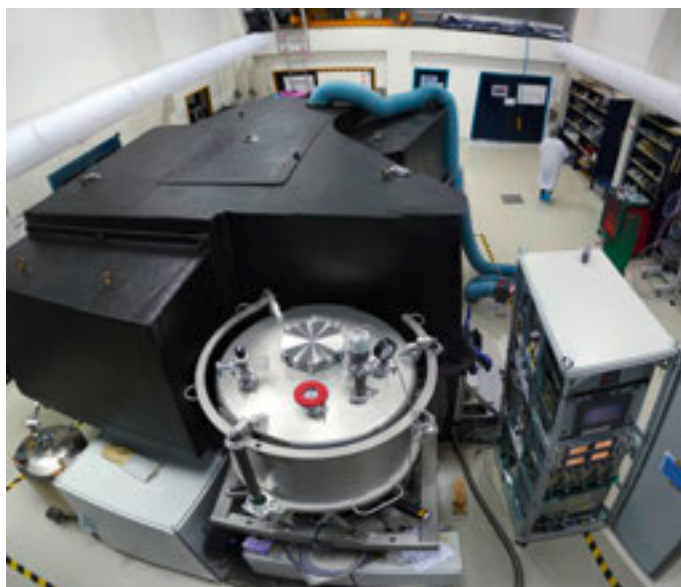

The SPHERE instrument is shown here fully assembled in the integration lab at Grenoble-IPAG.

maximum observing flexibility. The instrument detectors are a key item on the project critical path and a Final Design Review for these took place mid-year, allowing early procurement. The outcome of the review was successful and the contract for the procurement of the detectors was signed in July. The coude design concept was revisited and is now frozen to allow the final design work to proceed. Further development of the spectrograph optical design was also carried out, introducing a simple and more efficient camera, and eliminating the use of slanted volume phase gratings as cross dispersers, since these were found to be too risky in terms of sensitivity to alignment and efficiency.

Important progress was made in the Adaptive Optics Facility project with the start of integration of the final subsystems. By the end of the year most main subsystems were completely assembled, enabling the project to launch the AOF system test phase in 2013. Many key elements under contract with industry were delivered to Garching. REOSC (France) delivered the first science-grade thin shell for the deformable secondary mirror to Microgate/ADS (Italy). The Netherlands Organisation for Applied Scientific Research (TNO) delivered the four launch telescope units for the laser guide star facility and TOPTICA (Germany) validated the design of the 20 W sodium laser with extensive testing of a pre-production unit. Finally, Microgate/ADS delivered the deformable secondary mirror to ESO Garching in December, an exciting milestone, which passed without major difficulty. The adaptive optics wavefront sensor modules, GRAAL and GALACSI, were completely integrated with optics and all electronics, including the SPARTA real-time computers. The ASSIST test bench was also completed and accepted from the Netherlands Research School for Astronomy (NOVA) in October. Four of the required 12 low-noise wavefront sensor cameras (E2V CCD220 chips) were also delivered. In April, a major intervention was performed on the UT4 telescope to prepare the structure for the arrival of the AOF. The interfaces were implemented for the 4LGSF and a complete upgrade of the cooling system was carried out, along with other cabling activities. The telescope was successfully

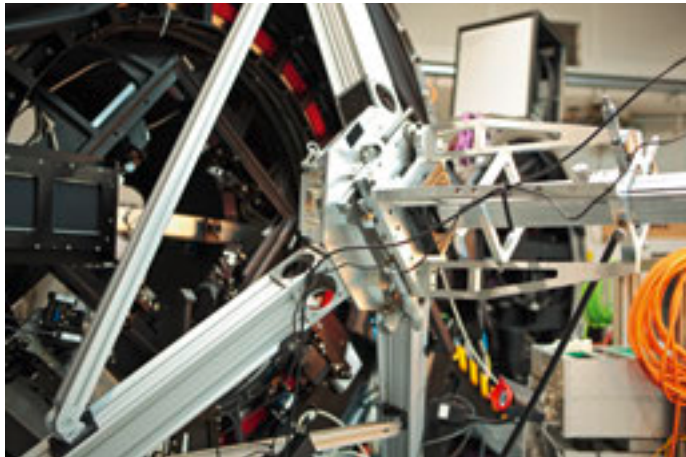

Image taken during GRAAL's mechanical assembly in the integration hall at ESO Headquarters in Garching bei München, Germany.

recommissioned after the intervention. Progress has been made in preparing the future operation of the AOF, and laser traffic control software has been tested in Paranal, a slope detection and ranging technique (SLODAR) upgrade was launched and requirements for site monitoring were issued.

The ERIS project to build a new facility at the UT4 Cassegrain focus to feed both an infrared imager and an upgraded SINFONI integral field spectrograph with adaptive optics (AO)-corrected wavefronts was approved. ERIS will use the deformable mirror of the AOF as well as

one of its lasers to improve both the resolution and sky coverage in comparison with the current NACO and SINFONI instruments. Opportunities exist for external institutes to collaborate with ESO on the construction of the instrument and a call for proposals was issued.

A four-month Phase A study for the Cassegrain *U*-band Brazilian ESO Spectrograph (CUBES) has been successfully completed with a review in September. A Brazilian consortium (PI: Barbuy, Co-PI: Castilho), in collaboration with ESO's Instrumentation Division staff, has developed an instrument design and operations

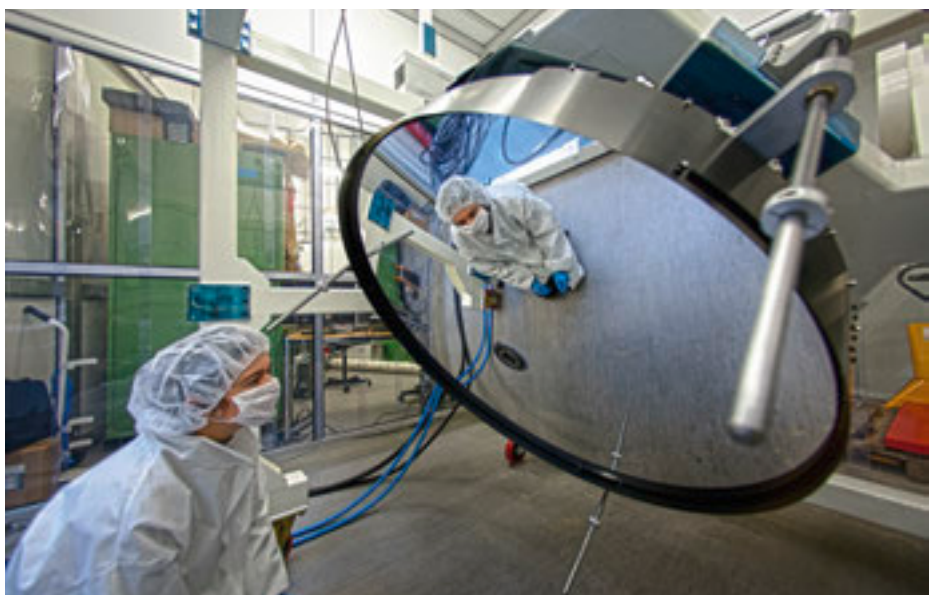

The new deformable secondary mirror for the AOF is shown assembled in the integration hall at ESO at the end of 2012, ready for further calibration and testing.

concept based on a detailed science case. These were presented to the Science and Technical Committee (STC) in October, who approved the go-ahead as an Instrumentation Division project contingent on Brazil becoming a full member of ESO.

The laser frequency comb (LFC), a revolutionary way of achieving a series of precisely equally spaced and stable lines for spectrograph wavelength calibration, was approved for construction for the HARPS spectrograph in 2011. This year the memorandum of understanding was signed between ESO, the Instituto de Astrofísica de Canarias (Spain) and the Federal University of Rio Grande do Norte (Brasil). The project aims to deliver a turnkey LFC for the HARPS spectrograph and comes as a natural extension of the development activities carried out in recent years to demonstrate the feasibility of this technique in astronomical spectrographs. Meanwhile, the analysis of the data of previous test runs has led to the demonstration of a short-term internal stability better than 3 cm/s, i.e., at the exo-Earth detection limit, a result that was published in the May issue of *Nature*. The HARPS+LFC system is expected to be commissioned by the end of 2013 and to be offered to the community in 2014. It should allow the detection of planets with only few times the mass of the Earth orbiting within the habitable zone of nearby solar-type stars.

VLTI instruments and infrastructure development

Progress on the two new instruments for the VLTI continued this year. The Final Design Review for the GRAVITY (PI: Eisenhauer, Max Planck Institute for Extraterrestrial Physics [MPE]) wavefront sensor was held in March and a number of critical actions were identified and are currently being addressed. Importantly, the SAPHIRA wavefront sensor detector (currently under development) has passed crucial tests, retiring one of the significant risks for the project. The interfaces in all laboratories and on the telescopes have been clarified between GRAVITY, ESO and the MATISSE and ESPRESSO teams. Hardware obsolescence is being addressed in collaboration

with Paranal. The remaining critical issue relates to how to deal with non-common path errors in the metrology injection. The MATISSE (PI: Lopez, Côte d'Azur Observatory, NICE) project has now closed all pending actions from the optics and cryogenics Final Design Review and the Final Design Review has been officially closed. MATISSE will increase its originally planned spectral resolution by using new gratings. A first cryostat, operating at the required temperature, has been completed.

A number of changes were made at the VLTI during the year. At the end of 2011 the VLTI Infrastructure Department was moved from the former Telescope Division to the Instrumentation Division. This allowed a restructuring of the general VLTI development project into several separated projects linked to specific scientific applications, as is commonly done for VLT instruments. The individual projects included (i) the development of the astrometric mode of PRIMA; (ii) the design and manufacturing of NAOMI, the adaptive optics system for the Auxiliary Telescopes; (iii) the development and improvement of the VLTI infrastructure necessary for the second generation instruments GRAVITY and MATISSE, including the reduction of UT vibrations; and (iv) the construction of a second generation fringe tracker to enhance the scientific output of these instruments. New managers from other departments and divisions were assigned to the VLTI projects and reinforced the VLTI team in order to accelerate the implementation. Two new staff members were recruited: Julien Woillez as PRIMA instrument scientist and Jean-Philippe Berger as VLTI Programme Scientist. Their tasks include helping the La Silla–Paranal programme manager to coordinate the activities of the various VLTI projects and prioritise them according to scientific objectives. The VLTI projects are now being structured and documented according to the standards used by all other VLT instruments and will be managed in an integrated way.

At the end of 2011, it became clear that the PRIMA astrometric mode would not reach the required accuracy, falling short by a large factor and strongly affecting the PRIMA science case. A dedicated

PRIMA analysis team was formed and received high priority to investigate the origins of the problem and to find solutions. The source of the large systematic errors was quickly narrowed down to a problem with the stability of the baseline (optical distance between telescopes) as seen by the PRIMA end-to-end metrology: due to optical effects the baseline was moving by several centimetres, while an accuracy of approximately 50 micrometres is needed. It was clear that a modification of the PRIMA metrology was necessary, extending it to include all the mirrors of the VLTI except for the telescope primary mirror. A rapid extension of the metrology revealed a very strong polarisation of light propagating into the VLTI. This effect is a showstopper for the PRIMA metrology and it is also present for normal interferometric applications, affecting their sensitivity and accuracy. In addition, the polarisation aspect is of utmost importance for the future GRAVITY instrument. PRIMA is therefore currently being used to fully investigate and understand the polarisation behaviour of the VLTI, to analyse its detailed effects both for PRIMA and GRAVITY measurements, and to find practical solutions to recover the metrology function and the expected accuracy. This experimental phase is currently being carried out. When this is completed, astrometric testing of PRIMA is expected to recommence around mid-2013.

In parallel, a small element of PRIMA has been put to good use: the fringe sensor unit has been offered for observations in combination with the first generation instrument MIDI. The fringe-tracker boosts the performance of MIDI on the Auxiliary Telescopes by increasing the limiting magnitude and improving the quality and accuracy of the data reduction. This mode is now used routinely in Paranal.

Right: This image shows one of the four ATs on Cerro Paranal, which form part of the Very Large Telescope. They are used for interferometry, which allows multiple ATs, or the even larger Unit Telescopes, to combine their power and see details up to 25 times finer possible than with the individual telescopes.





ESO/H.I. Heyer



The background image was taken in December 2012 and shows an aerial view of the central antennas that compose the Atacama Large Millimeter/submillimeter Array. The AOS building can also be seen on the right and, at the very far right, the APEX antenna. The historical image of the Chajnantor Plateau above was taken in 2002, before the construction of ALMA started.



ALMA, the Atacama Large Millimeter/submillimeter Array, is a large interferometer for radio wavelengths ranging from 0.3 to 9.6 millimetres. It is in an advanced state of construction by an international partnership between Europe, North America, and East Asia in collaboration with the Republic of Chile. Ultimately this new observatory will comprise 66 high precision antennas with state-of-the-art receivers located on the Chajnantor Plateau of the Chilean Andes at 5000 metres above sea level in the district of San Pedro de Atacama. The 12-metre antennas will be placed in configurations with reconfigurable baselines ranging from 15 metres to 16 kilometres. Resolutions as fine as 0.005 arcseconds will be achieved at the highest frequencies, a factor of ten better than the Hubble Space Telescope at optical wavelengths.

In 2012 ALMA construction has progressed significantly to the point that it is expected to be completed in 2013. The first scientific observations, ALMA Early Science, started in September 2011 and continued throughout 2012 with at least 16 antennas. The major highlights at the end of 2012 included:

- ALMA Early Science and science verification produced stunning science data. First results have been published with astronomers in the ESO Member States making a strong contribution.
- The call for proposals for ALMA Cycle 1 (scheduled to start in 2013) resulted in 1134 proposals, with 43% coming from the ESO Member States.
- ALMA construction proceeded well. Eleven European antennas were delivered in 2012, bringing the total to 17. FE deliveries were completed — including the Band 7 receivers and receiver cryostats — except for two FE assemblies which will be provided to the observatory in early 2013.
- By the end of 2012 there were 51 antennas (77%) from the three ALMA partners at the 5000-metre site, 40 of 12 metres in diameter, and 11 of 7 metres in diameter.
- First spectra and fringes were obtained with the Band 5 receivers, provided under European Union Framework Programme 6 (EU FP6) funding. The scientific interest and successful development



Aerial view of the OSF at 2900 metres above sea level. In the foreground is the antenna integration site where the antennas are assembled and tested by

the European, Japanese and North American partners, before being taken to their final destination on the Chajnantor Plateau.

of this receiver band has led to a decision to fully equip ALMA with Band 5 as the first development project.

- Commissioning of the permanent power system was completed and operations started to feed the OSF and the AOS technical building initially.
- The design of the ALMA Residencia was completed.

Site construction work

The ALMA Observatory comprises three sites:

- the ALMA Operations Support Facilities at 2900 metres above sea level;
- the Array Operations Site, located at 5000 metres above sea level on the Chajnantor Plateau; and
- the Santiago Central Office at ESO's Vitacura premises.

The OSF is the operations centre for the entire ALMA Observatory and is also the place where the final assembly of the antennas is carried out. The assembly, integration and verification of antennas and other advanced equipment is completed there before they are transported to the AOS.

Manned operations at the AOS are limited to an absolute minimum due to the harsh environment. The AOS technical building hosts the correlator, a specialised computer that processes the digitised signals from the antennas before they are transmitted via fibre optic lines to the data storage facilities at the OSF.

ESO has, within the agreement concluded with its international partners, assumed responsibility for providing several major construction works on all three ALMA sites. In addition, ESO has managed the construction of the roads leading from the Chilean public highway to the OSF (15 kilometres), and continuing to the AOS (28 kilometres). This year safety barriers and traffic signs were installed, completing the construction of the road, apart from the final element, which is the fully featured intersection with the public highway that is being studied in collaboration with Chile's Ministry of Public Works, the Ministerio de Obras Publicas.

At the OSF, ESO's infrastructure contributions are:

- the OSF technical facilities building;
- the permanent power supply system for the entire ALMA Observatory; and
- the ALMA Residencia.

The completed OSF technical facilities building has been in use since 2008. In 2012 the erection of a multi-fuel power generation system at the OSF, consisting of three turbines each with a capacity of 3.8 megawatts, was completed, and the plant was commissioned. However, after successful tests, one of the three turbines stopped working on liquefied petroleum gas (LPG) for reasons that are being investigated. The main fuel storage facility, with a total capacity of 600 cubic metres of LPG, was also completed and is now fully operational. The medium voltage distribution system that distributes the power generated across the facilities at the OSF and to the AOS was also completed and, after commissioning, entered into operation.

ESO/C. Cabrera



The LPG storage facility: the tanks are covered in sand for enhanced safety.

After the extreme precipitation that occurred early in the year, which caused substantial damage to the road and to the underground medium voltage cable installation connecting the OSF to the AOS, it was decided to issue a contract for a design that defines measures which would increase the tolerance to extreme weather events. This design was concluded with the delivery of a detailed plan. However, due to the rather high estimated cost, no decision has yet been taken on the implementation.

ESO/Kouvo & Partanen Oy



Wooden model of the ALMA Residencia.

The design of the ALMA Residencia, encompassing 120 rooms and all the required facilities such as the kitchen, dining room, general services, leisure facilities, etc. — contracted to the architectural office Kouvo & Partanen (Finland) — started early in the year and went through three reviews (preliminary, critical and final) to reach completion. However, the project deemed it necessary to change the location in order to reduce interference with the existing infrastructure, as well as to limit the risk of flooding in the case of extreme weather. This change required an additional effort by the contractor to adapt the design to the new location and this will be completed in early 2013. This additional activity, together with the envisaged complex bidding phase for the construction contract, could cause a delay in the readiness of the building with respect to the original schedule, moving the completion date into the first half of 2015.

Besides providing the 192 antenna foundations at the AOS (completed in 2010), ESO was responsible for installing high accuracy interfaces on them. This was a delicate and challenging activity since the required precision in positioning the interfaces is a few micrometres over a range of several metres, to be achieved in a rather harsh environment at 5000 metres above sea level. The work was completed this year.

ALMA antennas

ESO is providing 25 high-precision antennas to ALMA, each 12 metres in diameter. The antennas are manufactured by the AEM consortium, which is composed of Thales Alenia Space (France and Italy), MT-Mechatronics (Germany) and European Industrial Engineering (Italy). Component manufacture is spread across Europe at various subcontractors. The

antenna steel structures (mounts) are manufactured in Aviles, in northern Spain. There they are pre-aligned with great precision before they are shipped to Chile from the nearby harbour. The main dish structures and the receiver cabins, both made out of carbon fibre reinforced plastics, are fabricated, pre-assembled and measured in France. For overseas transport they are mounted on shock-limiting transport frames that ensure a safe road journey to Antwerp, and then on to Chile. Other parts of the antennas are either shipped directly to Chile from their production sites (like the reflector panels), or are integrated into the mount or the receiver cabin prior to each individual shipment.

The final integration of the antennas takes place at a large work area at the OSF, where various antenna foundations were constructed in 2008. These foundations are used to perform the mechanical and

electrical assembly of the antennas, the commissioning and the finishing work.

This year the delivery rate of the European antennas increased considerably. This resulted in eleven units being handed over to ALMA, bringing the total number of European antennas delivered so far to 17. This result is quite remarkable, considering that an extremely severe alpine winter disrupted acceptance testing activities between January and April. There were various reasons for this success, some the responsibility of AEM and others of ESO. First of all, industrial production in Europe continued with a regularity that ensured a steady flow of material to Chile. In Chile the AEM consortium was able to optimise the assembly process through various logistical and personnel measures. The best use of time was made possible by doubling the on-site presence of AEM staff with key technical skills, providing the flexibility to shift people between the various antennas under construction. AEM also modified the organisation of the workflow by introducing an antenna manager. The antenna manager is responsible for the antenna from the moment of its positioning on a foundation until its delivery to ALMA. The typical time between the start of integration and the final inspection that completes the testing phase was reduced to only six months, as compared to almost a year for previous antennas.

ESO efforts also contributed to these results. The antenna team had been constantly reviewing the acceptance test procedures to optimise the testing programme without assuming unnecessary risks. Whenever the experience gained with testing and operating the antennas allowed a step in the test process to be eliminated, this was discussed with AEM and implemented. The total time for testing an antenna was reduced from approximately ten weeks to typically six weeks. The number of equipment tools needed for testing was increased so that it was possible to test up to three antennas simultaneously with at least two looking at the sky. Finally, the high level of enthusiasm and effort from the people involved also contributed to the good results.

By the end of the year, all eight of the remaining antennas were positioned on assembly pads, each at a different stage. Two were in acceptance testing, while the two last antennas had just commenced their assembly. It is expected that the antenna project will be completed within the third quarter of 2013.

The year has also been very important for confirming the excellent performance of the European antenna design. The setting of the surface to the final specification, the integration of the front and back ends (BE), and the testing of the antennas prior to their relocation to 5000

metres were done expeditiously. The main reflector surface has always been set without problems at around (or better than) 11 micrometres root mean square (RMS), therefore providing a margin with respect to the specification and the error budget. This has allowed a steady flow of antennas to the Array Operation Site. By the end of the year fifteen European antennas were operating at the AOS.

The performance of the antennas at the AOS has been excellent, and basically confirms the measurements made at the OSF. In terms of pointing accuracy, all the antennas are around the 1-arcsecond RMS level in absolute pointing. Further, by means of astro-holography it has been possible to verify the accuracy of the reflecting surface directly on some of the units at 5000 metres above sea level. It was shown that the antennas did not experience measurable changes in shape as a result of their journey, that the error budget assumptions made at acceptance are correct, and that the antenna shape is largely independent of temperature variations. Tracking, pointing and on-the-fly mapping have also worked flawlessly at the AOS.

ESO has been systematically tracking any technical problems affecting the antennas in order to verify the reliability requirements and to detect any specific hardware items that require attention as early as possible. On the basis of the

View of the AEM assembly area at OSF from the holography tower, with eight antennas in completion and four steel structures parked (August 2012).



Holography result for antenna DA57 (European antenna #17). Left: The measured surface error at less than 9 micrometres RMS. Right: The illumination pattern.

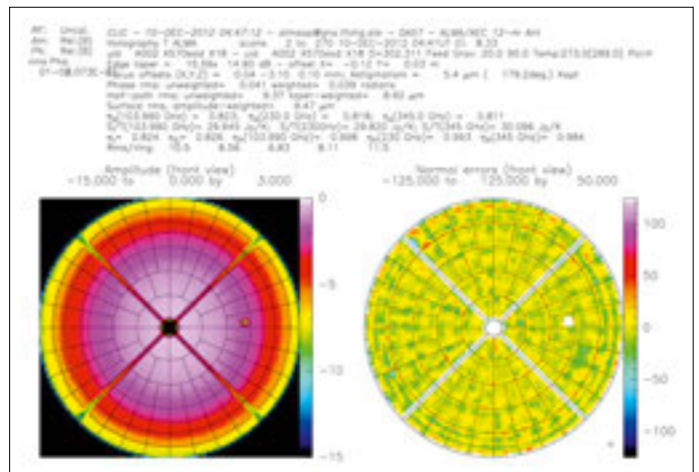

ESO/P. Calisse



Transport of DA50 (European antenna #10) to the high site in August 2010.



View of ALMA antennas at the AOS. In front, some of the European antennas.



View of the receiver cabin of a European antenna equipped with front and back ends.



Final reflector wash in the AEM area before delivery.

results obtained, a few minor retrofits were made to all antennas, eliminating initial issues and contributing to an excellent overall availability of the antennas. It should be noted that during the full year none of the AEM antennas had to be brought to the OSF for maintenance, and that corrective maintenance was limited to exchanges of line replaceable units at the AOS.

The front ends

The European Front End Integrated Project Team (FE IPT) was very successful in meeting its final objectives this year. The delivery of the various products

progressed according to schedule and all European FE subassembly production tasks could be completed, leaving only the delivery of two FE assemblies by the European Front End Integration Centre (FEIC) for 2013 (see table below).

Product	Delivered by 31 Dec 2012	Total	Fraction complete
Band 7 cartridges	73	73	100%
Band 9 cartridges	73	73	100%
Cryostats	70	70	100%
Water vapour radiometers	58	58	100%
FE DC power supplies	83	83	100%
Amplitude calibration devices	70	70	100%
European FE assemblies	24	26	92%

The excellent performance resulting in the delivery of 17 FE assemblies during the year could be attributed to two key factors. Due to an efficient operation, with excellent support from the FE systems engineers at ESO, the European

This table shows the delivery status of major European FE products by the end of the year.

FEIC at Science and Technology Facilities Council/Rutherford Appleton Laboratory (STFC/RAL, UK) was able to contribute 13 units. In addition, four units were integrated at the European FEIC and verified by the East Asian FEIC in Taiwan. The latter arrangement was made by ESO early in the year. The activity was organised and scheduled under the leadership of the European FE IPT in May and has been a great success due to the close collaboration and commitment of all the groups involved at the East Asia FEIC, ASIAA, the European FEIC at RAL and the European FE IPT located at ESO.

Two other major European FE sub-assembly production milestones were accomplished. The final Band 7 cartridge, SN73, was delivered in November by IRAM, ahead of the contractually agreed schedule. The last production cryostat, SN70, was delivered in October despite delays due to some performance issues with the (industry-supplied) cryo-coolers. A close interaction between RAL, responsible for the cryostat manufacture, and the manufacturer on these issues avoided further delays and kept the cryostat off the critical path.

Good progress was made in training JAO staff to maintain the FE IPT deliverables. Training for the Band 7 cartridge was provided, together with the Institut de radioastronomie millimétrique (IRAM), in the summer in Grenoble (France). The maintenance activities were evaluated and some additional training was provided for the Band 9 cartridges. To enable the JAO to be self-supporting in maintaining FE products, the necessary spare parts and specialised tooling and test equipment are being delivered.

The back end and the correlator

By the end of the year, all BE components to be supplied by ESO were provided to the ALMA Observatory on schedule and have been integrated into the overall ALMA system. The Back End IPT at ESO was closed on 31 December on the completion of its tasks.

The BE system is sketched in the figure above: ESO's deliverables are shaded in yellow. Each ALMA antenna is equipped

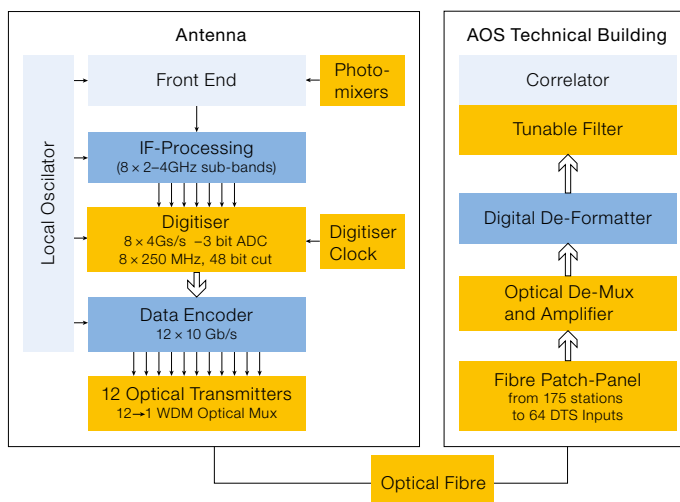

The ALMA BE system. Parts in yellow are provided by ESO.

with the elements shown in the left half of the schematic overview. Signals coming from the front end are processed, digitised and converted to one optical signal transmitting the scientific data through one optical fibre at a rate of 96 Gbit/second to the AOS technical building. The optical demultiplexer (de-MUX)/amplifier receives, amplifies

and de-multiplexes the optical signal from the antennas and conveys it to the tunable filter installed in the correlator. Each correlator input can be connected to each antenna station by means of a fibre optic patch panel and associated patch cables. The table below summarises the supply of BE components by ESO (completed by the end of the year).

Component	Supplier	Total	Received
Photomixers	RAL	619	619
Digitisers	Univ. Bordeaux	281	281
Digitiser clocks	IRAM	68	68
Optical transmitter MUX	ESO	80	80
Optical fibre patch cables sets	Huber+Suhner	2	2
Fibre patch panels	Huber+Suhner	2	2
Optical de-MUX and amplifiers	ESO	80	80
Tunable filters	Univ. Bordeaux	554	554

This table summarises the supply of BE components by ESO.

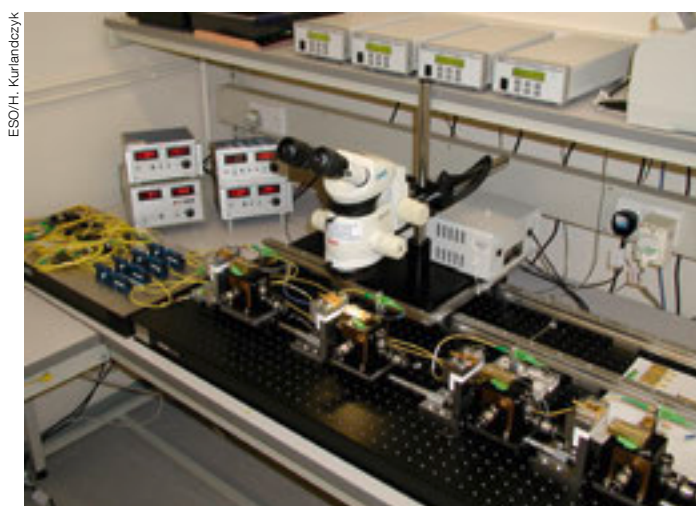

Fibre optics alignment for photomixer production at RAL.



Wide-angle view of the racks in one of the four quadrants of the correlator at the AOS.

The only major contract concerning the back end that was still running during 2012 was the production of photomixers. These devices allow a radio frequency (RF) reference signal to be extracted from an optical/infrared signal that is transported via fibre links from the technical building to each antenna. All units have been produced and most have been successfully integrated.

The ALMA correlator is a highly specialised super-computer processing data from up to 64 antennas at a maximum rate of about 2×10^{15} operations per second. The system performance and main design technical challenges are described in *The ESO Messenger*, 135, 6, and the *ALMA Newsletter*, 7, 18.

The two-quadrant configuration of the correlator was in continuous use at the AOS for Commissioning and Science Verification (CSV) tasks and Early Science projects, with no major functional problems reported from CSV or the users until September. At this date the correlator operation had to be stopped for a short

time in order to prepare for the on-site transition to the full four-quadrant system for later operation with more than 32 antennas. Up until September the third quadrant was mainly used as a test bed to monitor event upsets caused by cosmic rays at the AOS site, at 5000 metres above sea level. The fourth quadrant was disassembled from the integration site in Charlottesville (USA) and AOS on-site acceptance was completed in July. The 64-antenna deployment plan was prepared, the hardware and software were successfully tested and ultimately the handover from the correlator Integrated Product Team to the Joint ALMA Office was accomplished in December.

The general performance of the 64-antenna correlator and its main features were presented at the Early Science meeting of the Nordic ALMA Regional Center in Gothenburg and at the SPIE astronomical and instrumentation 2012 conference in Amsterdam.

Collection of statistical data on event upsets due to cosmic rays continued and

a first quantitative analysis was completed. An event upset rate was derived for the entire correlator system of 10.3 events per day and, in two cases, our analysis suggests that such events were the root cause of two hardware problems. A control code allowing us to monitor currents has been updated accordingly and a strategy to mitigate the event upsets by flagging and reloading the firmware in the affected hardware is being discussed currently.

ALMA computing

ALMA computing is responsible for developing, maintaining and supporting all the software for the ALMA Observatory and its regional centres.

This has been a year of transition for ALMA computing. The team had to master the challenging task of supporting science operations in a stable environment, whilst still developing new and improved software applications at full steam. The software has improved

significantly in all areas, with a particular focus on stability, scalability, performance and usability. The processes for testing and delivering the software have been further improved to deliver high quality software to the observatory.

It was also the final year during which ALMA computing was a part of the ALMA construction project. From 1 January 2013, ALMA computing is fully funded by the ALMA operations budget. As such the European part of the Integrated Computing Team is now a department of the European ALMA Support Centre within the ESO Directorate of Operations.

As foreseen in the ALMA operations plan, the trilateral ALMA computing Integrated Product Team — with proportionate contributions from Europe, North America and East Asia — merged with the computing group at the Joint ALMA Observatory to form the quadrilateral Integrated Computing Team (ICT). An implementation plan with a detailed description of the organisation, its roles and responsibilities, the decision-making processes and the interfaces to all stakeholders has been prepared and was approved by senior management in mid-2012. Most of the required changes have already been implemented, while some will be rolled out in the course of 2013 for practical and operational reasons. Most of the staff members have been kept in their positions at all four partners with only gradual changes foreseen in the coming years. This guarantees a smooth evolution with little impact on the ALMA computing stakeholders.

The European part of the ICT (ICT-EU) is responsible for several software tools and components, including the ALMA Archive, ALMA common software, the Observing Tool, the Phase 1 manager, the project tracker, the science and user portal, the executive software, the shift-log tool and the telescope calibration software. ICT-EU also leads the Software Engineering and Quality Management group for ALMA software, and the Integration and Release Management team. The role of the release manager, who will be responsible for the delivery of high quality ALMA software to the observatory, has been established in Europe and was handed over to the Chilean ICT late

in the year. Responsibility for integration and testing will be transferred gradually to Chile in the course of 2013. ICT-EU also contributes to the Data Processing group for the ALMA data reduction software, CASA, and the science pipeline and the Control group, both of which are led by NRAO.

The European ALMA Support Centre leads the European ICT, with strong support from the ESO Software Development Division. Other developers come from the UK Astronomy Technology Centre (UK ATC) in Edinburgh, IRAM in Grenoble, the Max Planck Institute for Radio Astronomy in Bonn and the Observatoire de Paris.

System Engineering and Integration

The European ALMA System Engineering (SE) team continued to work on all SE activities in close collaboration with the worldwide ALMA SE. Specifically, system verification continued and the European team was involved in verifying requirements such as signal dynamic range, cross-talk between polarisation and spurious signals. ALMA has entered a phase in which work has shifted more and more to verification, analysis, troubleshooting and acceptance. In parallel, project-level documentation was kept up to date. SE personnel participated in or chaired design reviews and acceptance events.

The European Product Assurance (PA) structure and reporting introduced in 2011 has successfully shown that it can enable the European ALMA project manager to identify critical PA issues in a timely manner and react accordingly. Additionally, an effort to assess the reliability, availability, maintainability and safety (RAMS) status of the European deliverables has been introduced. This has allowed the identification of missing critical RAMS elements, ensuring a smooth handover to operations.

ALMA science

The year 2012 was the first year of ALMA science, with the first scientific results from the analysis of science verification (SV) and Early Science Cycle 0 data pub-

lished in refereed journals. Some of the major themes of ALMA science that appeared through the year are discussed in the Research Highlights section of the report (see page 11), and many more results were presented and discussed in December 2012 at the international conference, The First Year of ALMA Science, jointly organised by JAO and the ALMA partners with the co-sponsorship of the EC FP7 Radionet3 project. A detailed account of the conference has been published in Testi & Andreani 2013, *The ESO Messenger*, 151, 50. Most of the presentations are available on the conference website (<http://www.almasc.org/2012/>). Many of the science results published in 2012 are based on the analysis of the publicly released SV datasets. During the year, ALMA SV data were released, covering a variety of targets suggested by the external community and demonstrating a wide range of instrumental capabilities. Detailed information on the ALMA SV data and plans are available on the ALMA science portal (<http://almascience.eso.org/alma-data/science-verification>, see also the report by Testi et al. 2012, *The ESO Messenger*, 150, 59).

ALMA Commissioning and Science Verification (CSV) activities continued throughout the year with the aim of commissioning and delivering observing modes to the Science Operations team. The CSV work focussed for most of the year on delivering the additional capabilities that will be available in Early Science Cycle 1 (starting in 2013). In addition, several successful campaigns to develop on-axis polarisation and solar observing modes were held throughout the year. The focus of these activities is now shifting to the new capabilities that will be offered in future cycles, including the new Band 4, 5, 8 and 10 receivers, longer baselines, more complicated correlator modes and full polarisation modes. As in previous years, European institutes continued to contribute significantly to the CSV efforts throughout 2012, both participating in the activities in Chile and supporting data analysis and algorithm development from Europe.

Several workshops, meetings and tutorials on ALMA science were organised in 2012, mainly in collaboration with the ARC network (see page 40) and the



ALMA SV observations of Centaurus A demonstrating the high resolution and high sensitivity wide-field mosaic capabilities of ALMA. The colour scale represents the line of sight velocity of the CO(1-0) molec-

ular gas in the plane of this nearby active galaxy. The ALMA data also reveal the rotation pattern of an inner massive disc surrounding, and possibly feeding, the central supermassive black hole.

groups working on the ALMA development plan studies. The ALMA Community Days were held in June ahead of the Early Science Cycle 1 deadline so as to prepare the community for the best use of the newly offered ALMA capabilities (see report from Randall et al. 2012, *The ESO Messenger*, 149, 47). The scientific potential of ALMA as part of the millimetre VLBI (mmVLBI) global network was also discussed in a dedicated workshop in Garching (see Falke et al. 2012, *The ESO Messenger*, 149, 50).

The ALMA upgrade study “Preparations for Full Production of ALMA Band 5” was

completed early in the year and the resulting science case and proposals for production were submitted to the relevant ESO and ALMA bodies. The full production project for Band 5 was then approved at the ALMA Board meeting in April 2012. In 2012 there was also excellent progress in exploring the options for future upgrade of the Band 9 receiver to sideband-separating operations and in the definition of the work required to phase the ALMA array (required to use ALMA as a station of a mmVLBI network and other applications). Two additional upgrade studies were launched in 2012. One focussed on the development of the

science case and components for a receiver cartridge with very wide band 67–116 GHz (covering both the ALMA Bands 2 and 3) and with at least 16 GHz per polarisation instantaneous frequency coverage. A second study is focussing on the science case and instrument, operations and site constraints for a supra-THz receiver for ALMA (Band 11).

ALMA enhancement programme

This year ESO continued to lead a consortium of six scientific institutions providing additional software and hardware to enhance the performance of the ALMA Observatory. These activities, which have been entirely supported through the European Union’s Framework Programme 6 (FP6) since 2006, were successfully completed by 30 September 2012.

IRAM (France) has developed sophisticated techniques for on-the-fly observations. The University of Cambridge (United Kingdom) has successfully implemented software for radiometric phase corrections, which is already routinely used by ALMA. Specialists from Chalmers University of Technology (Sweden), STFC/RAL (United Kingdom) and the University of Chile have designed, developed and assembled six ALMA Band 5 receivers, covering the frequency range from 163 to 211 GHz.

Five of the Band 5 receivers were installed at the ALMA Observatory and first light was obtained in April with the first interferometric fringes recorded in October. A first test observation in August demonstrated the scientific potential, even under modest weather conditions, by observing a SiO maser and water emission.

As a follow-up to the very successful development of Band 5 and the provision of six cartridges under the EU FP contract, equipping all ALMA antennas with Band 5 receivers has been set up as the first ALMA development project approved by all relevant governing bodies of ESO and ALMA and funded by the ESO-ALMA Development Programme.



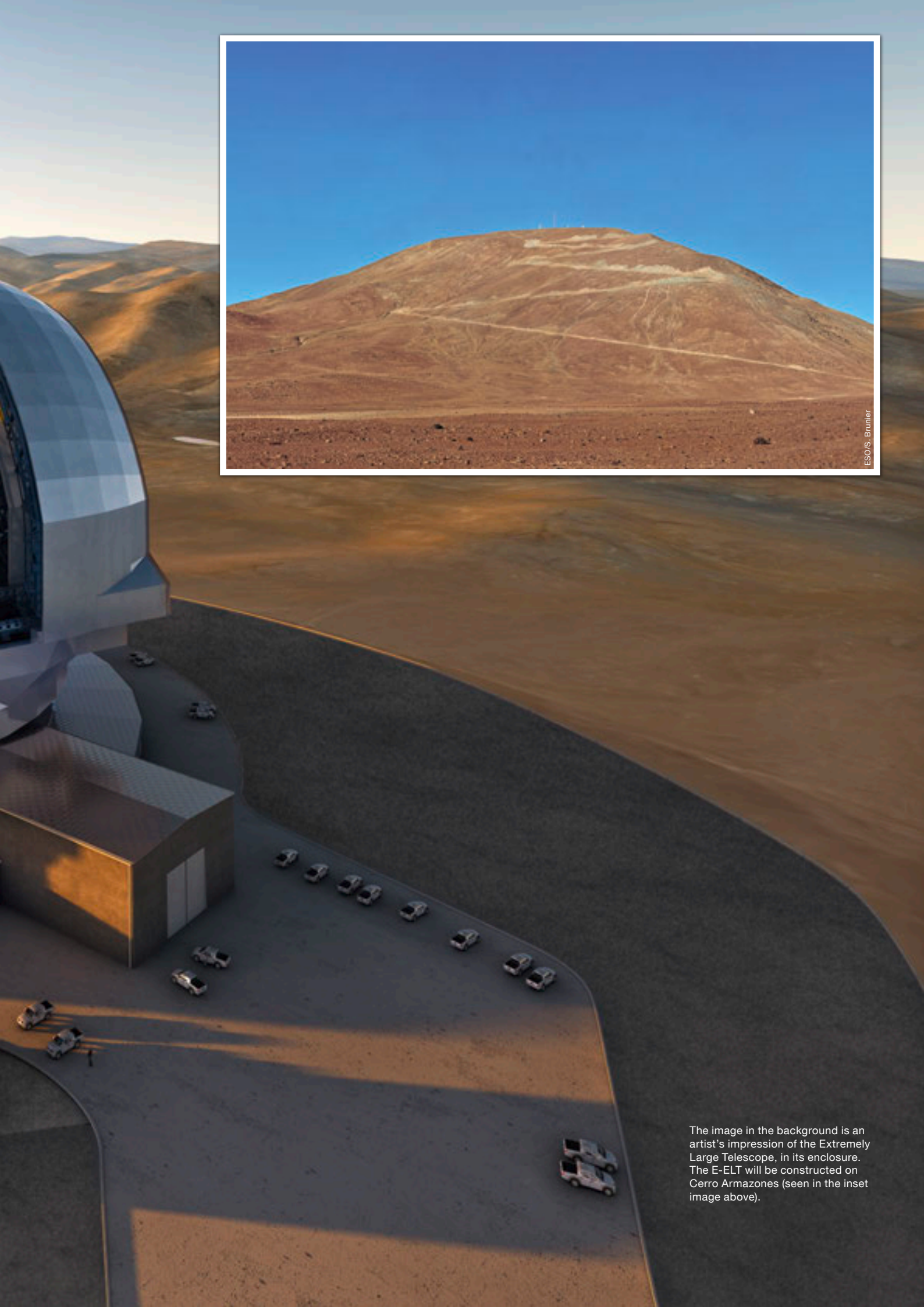

ESO/S. Brunier

The image in the background is an artist's impression of the Extremely Large Telescope, in its enclosure. The E-ELT will be constructed on Cerro Armazones (seen in the inset image above).

European Extremely Large Telescope

The E-ELT project passed a series of critical milestones during the year 2012. June brought excitement as the project was approved by the ESO Council with ten positive votes. With this project approval and its subsequent confirmation in December, the ongoing preparations for the start of contracting in 2013 have assumed a high level of urgency.

The first contract for the construction project was approved by the Finance Committee in May. The contract began in the summer, and is now up and running. This is the design and construction of the large deformable mirror by the Italian firm AdOptica and it marks the start of the E-ELT project. This mirror is 2.5 metres in diameter and is the fourth in the telescope train, providing not only corrections for the atmospheric turbulence, but also for aberrations induced by the telescope itself. It is a critical component of the wavefront control strategy for the E-ELT and was the critical path item in the schedule. As was reported in last year's Annual Report, the years 2011 and 2012 have been designated as "bridge years" that will allow us to consolidate the design around the 39-metre baseline and, most critically, reduce the risk in the project. By launching the contract this year, one of the critical programmatic risks has been mitigated. On the technical front, as was reported last year, investigations are continuing with respect to the material for the reference body for this unit. The reference body provides the surface against which the thin (2 millimetre) sheet mirror is actuated, giving the control system the ability to generate absolute commands to control its form.

The contract for the design of the access road to the site has also been concluded and all the planning is underway to start work on site. Care had to be taken in the access route to ensure a minimal impact on the site environment. Site characterisation continues with the meteorological and seeing conditions being monitored continuously and additional seismic measurements being planned. The overall characteristics of the region and the particular location received significant attention during the design phase for the telescope. The E-ELT project is now investigating the local amplification factors arising from the particular geometry

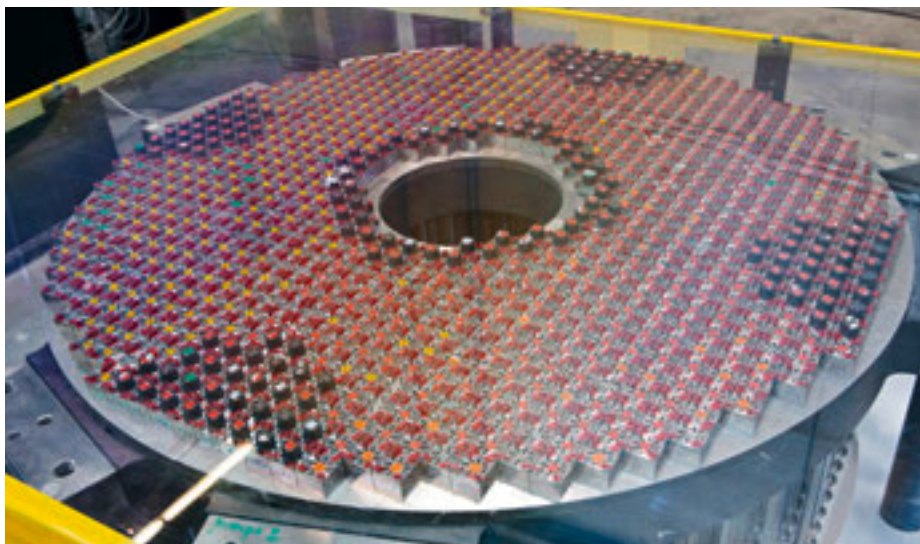

The E-ELT M4 mirror support at the Hochbrück warehouse in early 2012.

of Cerro Armazones. The power supply and distribution for, and at, Armazones has also received a lot of attention from the project team. Power is likely to be a significant fraction of the operating cost of the E-ELT and optimising the design of the system is an important aspect of the design work.

The prototyping work has continued at a rapid pace throughout the year. Since 2010, the ESO warehouse in Garching Hochbrück has had a separate area designated for integrating and testing the systems developed and delivered by various contractors. Most of this year's activities have concerned the primary mirror segments. These have been integrated in the test stand and equipped with actuators and edge sensors. This work has been crucial for developing a clear understanding of the detailed interactions between the whiffletree supports for the segments and other components of the system. These include the actuators that provide piston and tip-tilt capabilities for the individual mirrors; the warping harnesses that are integrated into the mirror support units that enable the manipulation of the mirror shape and the correction of the effects of gravity and temperature on the mirror substrate; and the edge sensors that monitor the positions of the mirrors relative to one another. Two sets of mirror supports have been undergoing tests with very different concepts

and much has been learnt about the integration and operational challenges arising from these prototypes. Although the performance is largely very good, improvements can be made in the ease of operation and maintenance that will be included into the next design phase or directly into the design and construction contracts in the future.

The prototype actuators were also produced in two flavours, one based on piezo technology and the other on voice coils. Although these are procured as individual components, making sense from a maintenance point of view, we operate them in triplets, which allows for a coherent approach to the global problem of managing the tip-tilt of the mirror without introducing spurious piston motions. The combined operation of edge sensors and actuators has been achieved with excellent results. These activities are critical components of the work to prepare for the construction since they ensure that a wide range of issues is addressed. These issues range from what may be considered trivial, for example, reserving design volumes under the primary mirror to host units, to highly complex control issues, for example, noting the interactions between actuators.

The tests in Hochbrück have also allowed the E-ELT project to test its software and



One segment of the giant primary mirror of the E-ELT undergoing testing at the Hochbrück warehouse in 2012.

system is ensuring that we achieve a rapid start-up when the contracts are issued.

The E-ELT Project Science Office has been active in the generation of the revised top level requirements for the E-ELT. This revision followed the decision to move to a 39-metre baseline and a single managerial structure that incorporates the instrumentation programme, the telescope and infrastructure. Additionally, the top level requirements for the two first-light instruments have been extensively discussed. With the end of Phase B the two committees that provided support, guidance and oversight to the design project — the E-ELT Science Working Group and the E-ELT Science and Engineering Committee — ceased their activities. A new advisory Project Science Team (PST) has been created, based on volunteers from the community selected by ESO. The PST met three times this year and has been actively involved in the drafting of requirements for instruments etc. Oversight for the project will be provided by the STC and its subcommittees.

The active engagement of the broader community in the E-ELT project has resulted in a number of workshops and science days during the year. Meetings with industrial suppliers were held, culminating in a very well-attended two-day presentation to potential contractors for the dome and main structure at the Allianz Arena in Munich in October. One hundred companies and organisations from some 15 countries attended, with almost all Member States represented, and many industrial liaison officers in attendance. Observers from Turkey also took part. Feedback has been very positive. Industry days were also organised in Italy and Switzerland, and a visit from a Chilean delegation was organised in Garching.

The scientific case for a high-resolution spectrograph was discussed in Cambridge in September, that of multi-object spectroscopy in Amsterdam in October, while in London, a two-day meeting was held in November at the Royal Astronomical Society to discuss the E-ELT priorities. During the European Week of Astronomy and Space Science in Rome, a dedicated session was held on the E-ELT.

hardware infrastructure concepts with much success. A diverse set of hardware has been interfaced with the ESO system without the need for a large software effort either from the suppliers or from ESO. Much of this is achieved by following a move away from the custom solutions that have dominated science projects in the past to more industrial engineering norms. Another example of such an evolution away from bespoke engineering has been the prototyping by the Danish firm FORCE of a full-scale real-time computer for the basic functions of the adaptive mirror of the E-ELT. The FORCE system is built using only four off-the-shelf standard personal computers and does not employ any dedicated hardware. Moreover, it operates with standard software making it, in principle, portable and economical. Although this risk had been considered largely mitigated in the past by employing smaller scale prototypes, the full-scale machine and its simplicity have provided a clear vision for the future of the high performance computing needs of the E-ELT.

In addition to the mirror segments already supplied to ESO by SAGEM/REOSC, some units are being manufactured by two further suppliers, namely OptIC Glyndŵr in North Wales and the Laboratoire d'Astrophysique in Marseille. The breadth of possible suppliers is underpinned by using different technologies for the polishing, and provides a very strong indication of the industrial readiness of European firms to engage in the E-ELT. Second generation prototype actuators

are being manufactured by Physik Instrumente of Germany and second generation edge sensors by Micro-Epsilon of Germany and FOGALE of France.

The in-house E-ELT team has continued its work on the validation of the baseline reference design. Revisions to requirements and lessons learnt from the prototypes are being generated for the segment supports, the dome and the main structure of the telescope. Some of this work is supported by a number of small engineering contracts, for example Arup in the UK has undertaken a detailed study of the interface between the telescope main structure and the dome. Furthermore, the in-house engineering team has proceeded with a painstaking and thorough review of all telescope requirements with the object of removing overlapping constraints and clarifying issues that arose during the Phase B design stage. Much effort has been expended in the computational fluid dynamics simulations of the telescope and dome in a variety of conditions, resulting in a better understanding of the air flow within the dome and an evolution of the ventilation requirements.

The programmatic effort continues with the work breakdown structure and the product tree being incorporated into the scheduling toolkit. This results in many of the instruments and tools of project control being firmly embedded in the project structure. For example, the incorporation of the E-ELT documentation archive into the ESO product data management

Engineering



ESO/C. Madsen



J.L. Dauvergne & G. Hüdepohl/ESO

Technology Division

The Directorate of Engineering comprises the Software Development Division (SDD) and the Technology Division (TEC). The Directorate provides resources to project and operations teams in the following engineering disciplines: control engineering, electronic engineering, information technology, mechanical and opto-mechanical engineering, optical and photonics engineering, software engineering, and structural and systems analysis. Its mission is to deliver the requested services with high quality and in a cost-effective way. This is now achieved by optimising the allocation of resources, developing and maintaining engineering standards that meet the project requirements, and promoting synergies between projects where applicable.

The development of the matrix structure, required to carry out multiple programmes efficiently and in parallel, will continue until the end of 2013.

Left: A spectacular aerial view of the ESO Very Large Telescope platform, atop Cerro Paranal, in the Chilean Atacama Desert. The top of Paranal's summit was a sharp peak, as seen in the aerial shot overlaid, taken in 1991 when the VLT construction started. It had to be truncated by about 40 metres to create a wide platform.

Following the engagement survey that was carried out in 2011, the Technology Division has worked to analyse and implement the suggestions and proposals that were made to improve workflows and staff engagement, as well as to clarify the strategies. As a result, team spirit and satisfaction have improved, with further advances expected when the measures already put into practice are followed up.

The Technology Division has been working to provide an electricity connection to the Chilean national grid for the future Paranal–Armazones Observatory. The local Chilean institutions are providing support to bring a distribution network into Paranal's vicinity. There are several companies that are studying the case and there is some progress in the matter.

After the signature of the VISTA agreement that followed the telescope's delivery, the VISTA building extension is progressing, with the civil works underway and the coating unit dismantled ready for its upgrade.

TEC continues to promote ESO in order to fill the needs for specific industrial technological support from various industries. This was achieved through ESO's Industry Days, held this year in Denmark, Finland, Italy, and Switzerland.

This year, the TEC Mechanical Department, with support from IT and other Divisions, has implemented the new product data management tool, which also replaces the technical archive for all the technical documentation. This is the new ESO standard platform for all technical and project documentation.

As part of the Directorate of Engineering, TEC contributed to defining the management of the ESO Engineering Standards, as well as to the process for keeping their configuration under control.

The Paranal Observatory is starting to face concerns with obsolescence. Together with the SDD and the observatory itself, TEC has developed a plan to mitigate these obsolescence issues — mainly relating to the electronic, software and control systems — in a way that

takes account of the design solutions proposed by the E-ELT.

The new fibre laser system at UT4 (the PARLA laser, replacement for PARSEC) was finalised during the last quarter of 2012 and the final stages of European testing were successful. The parts were then shipped safely to Paranal, where its integration onto UT4 will take place during the first quarter of 2013. First light is planned soon afterwards.

Electronic Engineering Department

Although wireless and mobile phone infrastructure and services are common in our lives, ESO policy has always been to strictly forbid their use in the vicinity of the telescope to avoid potential perturbations to the telescope and instrument control systems.

This year, electromechanical component experts from the TEC Electronic Engineering Department (TEE) have measured the effects of a wireless service *in situ* to evaluate the real impact on observations and potentially grant permission for such a service on our observing premises.

As part of the LPO obsolescence management plan programme, the UT1 safety chain upgrade project was approved and the work is proceeding, with completion planned for 2013. The aim of this project is not only to manage the obsolescence of the telescopes, but also to align their safety levels with the current European norm.

In October, TEE successfully virtualised an old Virtual Machine Environment (VME) motion controller board using cutting-edge field programmable gate array (FPGA) technology. Thanks to this proof of concept, we have demonstrated the usability of such technology to address the obsolescence of our control systems at Paranal.

Regarding the E-ELT project, TEE has concentrated its main activities on the M1 test stand evaluation in ESO facility at Hochbrück, with preparatory work directed towards the re-development of the M5 control system.



Net radiometer installed on the future E-ELT site.

Mechanical and Cryogenic Engineering Department

UT4 has undergone its first preparations for hosting the Adaptive Optics Facility. This upgrade includes the installation of new cooling circuits; the modification of cable wraps to increase capacity; the installation of new cables and the rerouting of existing cables inside the centrepiece. This requires the drilling of 1100 holes and the addition of 9 tonnes of equipment to the centrepiece. The work was completed during a mirror recoating period in order to reduce the telescope downtime, requiring the many experts from Garching and Chile to work together in shifts with very tight deadlines.

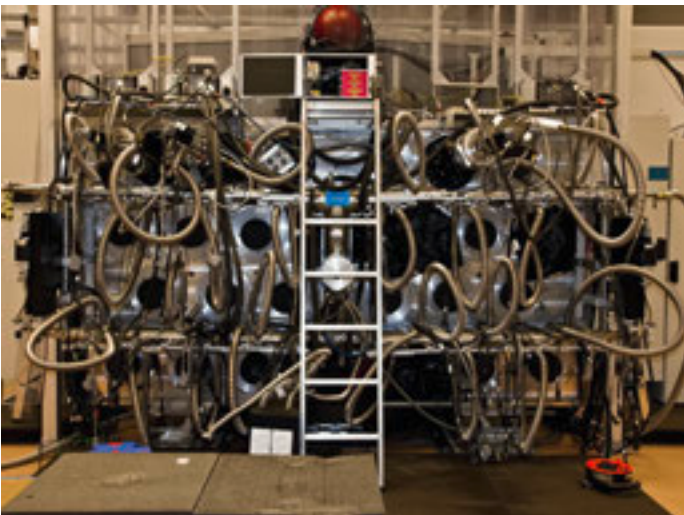

Overview of the charge coupled device (CCD) assembly for MUSE.

An important component for the AOF has been delivered to ESO, namely the deformable secondary mirror for UT4. This is designed to replace the existing secondary mirror. It has been integrated into a purpose-built test facility called ASSIST and is undergoing system testing at the ESO facilities in Garching. One goal of this facility is to be capable of simulating the optics of UT4 in order to verify the performance of the AO modules (GRAAL and GALACSI) prior to delivery. These AO modules are also currently being integrated and tested in Garching.

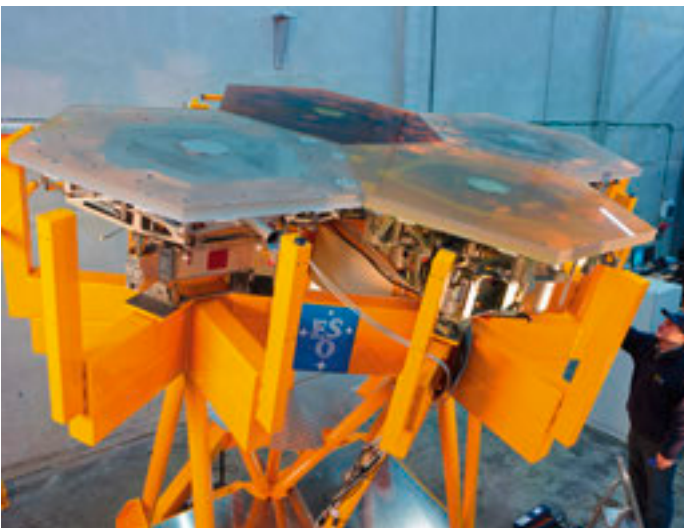

E-ELT M1 test stand in Hochbrück.

The presence of the new document management system has involved setting up and rationalising many existing processes to allow all engineers to work in a single environment. In parallel, a dedicated system to manage 3D CAD files has also been implemented allowing engineers to easily share designs and ideas.

The department provided the VISIR infrared spectrometer upgrade with a new disperser system, two detector systems and the installation of new prisms. This work has involved redesigning cryogenic sub-units that integrate into the existing instrument.

Optics and Photonics Department

Working with the other TEC departments, a new fibre laser light source, PARLA, has been developed and was shipped to Paranal in November. This laser will be used to upgrade the existing Laser Guide

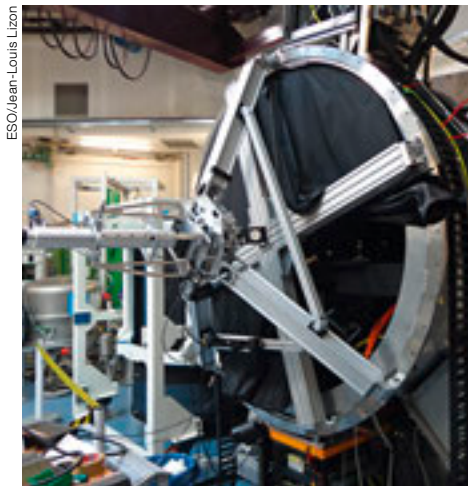

Optical alignment of a new AO module (GALACSI) for UT4.

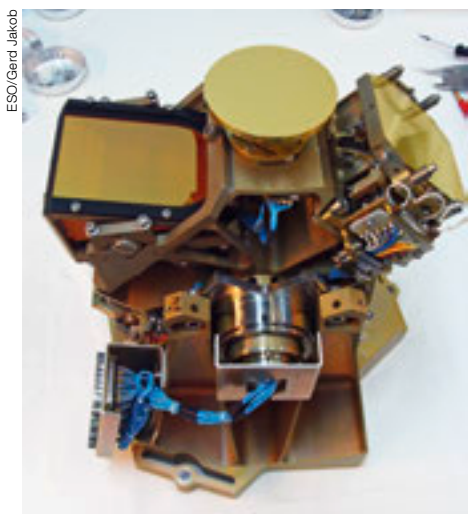

Upgraded VISIR grating carousel wheel with prism mount.

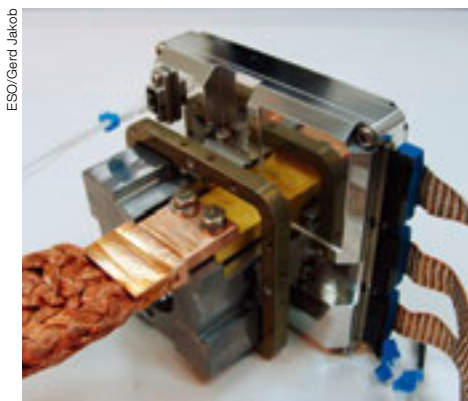

AQUARIUS detector mount for VISIR.

Star Facility on UT4. The goals of the upgrade are to offer more flexible observing with the laser and to increase the availability of the system. The laser generates a powerful yellow beam at the sodium wavelength of 589 nm which is used to create laser guide stars for adaptive optics. It is based on the same Raman fibre laser technology that ESO is developing for the planned Four Laser Guide Star Facility of the Adaptive Optics Facility. This future system, which continued development during the last year, will deploy four 20 W sodium laser guide star units on UT4.

New non-circular optical fibres have been evaluated in the fibre laboratory for linking future spectrographs like ESPRESSO that require extreme photometrical stability. For example, octagonal fibres would allow ESPRESSO to measure radial velocities with an unprecedented accuracy down to 10 cm/s.

A prototype of a compact, high resolution, high stability fibre-linked spectrograph to be coupled to an LFC calibration source is under development. The goal is to offer an extremely accurate spectrograph facility for calibration purposes. A preliminary test bench spectrograph assembled with off-the-shelf components has reached the required resolving power of 100 000.

Structures and System Analysis Department

The Structures and System Analysis Department has contributed to the consolidation of open issues of the E-ELT



PARLA laser with its powerful yellow beam at the sodium wavelength of 589 nm.

requirements and to the procurement specifications update of the main structure, dome and M4 unit. Based on detailed structural, control and ray-tracing models, system analysis support was provided to evaluate performance budgets (e.g., wavefront, stroke, deformation) of the complete telescope including its subsystems and to derive requirements at various specification levels. Earthquake analyses of the assembly telescope, pier and seismic isolation system were carried out to evaluate the subsystem accelerations and the integrity of the structure.

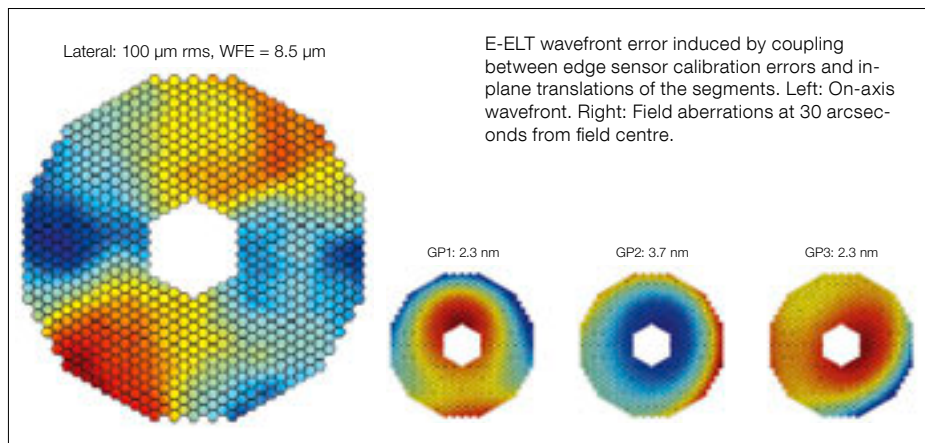

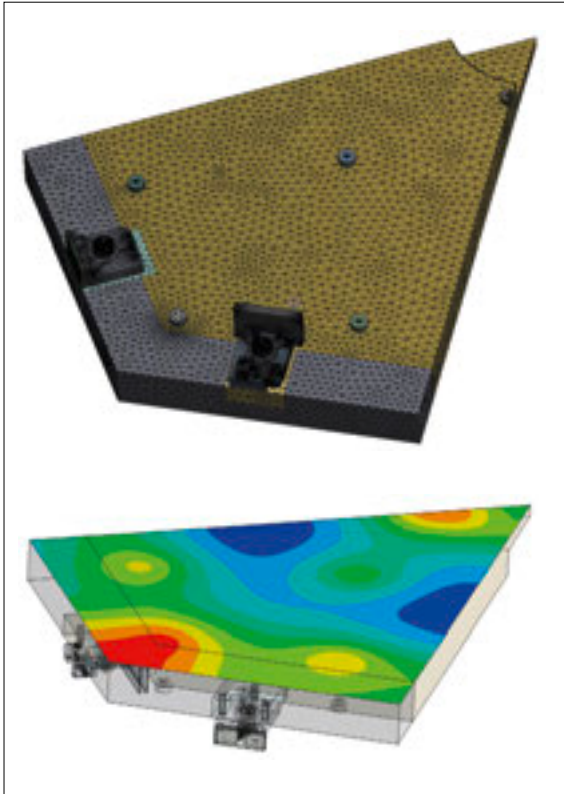

E-ELT edge sensor finite element model.

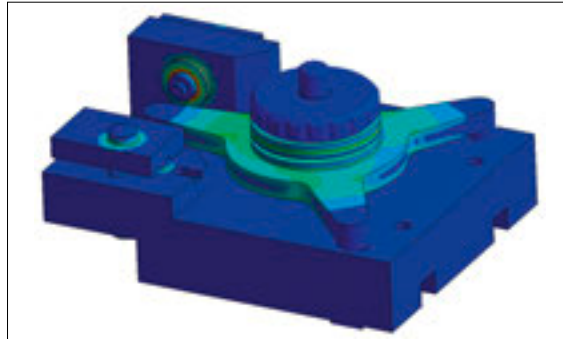

E-ELT edge sensor stress distribution.



The 4LGSF optical test assembly on the test stand.

Computational fluid dynamics simulation studies of the dome confirmed that a larger louvre area is beneficial to flushing at low wind speeds.

Considerable progress was made in characterising the metrology polarisation problems of PRIMA by a measurement campaign on Paranal, adaptation of the VLTi end-to-end ray-tracing model and by polarisation analysis. Preliminary conclusions are that recoating some optics (e.g., M9, feeding optics) may alleviate these problems.

In addition to contract follow-up, design and analysis support was provided to the LPO projects 4LGSF, NTT, VST and the UT4 upgrade.

The main contributions to ALMA concerned the support of the antenna acceptance at the OSF and the production activities in Europe. This consisted primarily of remote support from Garching of the pointing acceptance activities of the European antennas, numbers 8–19.

The ESO standard engineering analysis document has been written and released.

Control Engineering Department

In August the Control Engineering Department (TCE) installed, in collaboration with observatory staff, ESO Standard Telescope Axis Controllers (ESTACs) in all four Auxiliary Telescopes. These are now fully commissioned with the new controller and show improved performance and reliability.

Preparation for installation on the UTs was done and the deployment will now start, with preparation for a VST upgrade running in parallel.

In the LPO obsolescence management programme, the VLT M1/M3 upgrade was approved and the work is continuing, with completion planned for 2013. Many of the VLT systems were put into operation more than a decade ago; they contain specific electronic components that

are no longer available and must be replaced with modern alternatives.

TCE provides control engineering support to all E-ELT systems and has a leading role in the E-ELT M1 test facilities, M1 control system, position actuator prototypes and the instrument control system framework. Prototype sensors and actuators have been tested and integrated into the test setup. They are also placed in the M1 control system in the E-ELT M1 test facilities, and extensive tests are in progress.

In the field of adaptive optics, an extensive study of the impact of latency and jitter on the performance of wavefront real-time computers confirms that the requirements of the E-ELT are adequate.

Vibration is an important topic that has led to a study of damping and rejection technologies for the E-ELT segmented mirror system and development of rejection algorithms for the adaptive optics systems of the VLT.

The VISTA survey telescope is a marvel of engineering.



Software Development

The challenge for the SDD remains the provision of the requested resources and products to each project and operations team, whilst monitoring the quality of the work being done, the standards in use and, where appropriate, the commonalities between projects.

General IT Department

The IT Service Department provides general IT services to the whole organisation, including support for network and communication services, general servers, desktops/laptops and applications. The mission of this department is to provide, maintain and support a secure, high performance and reliable IT infrastructure. The department consists of two groups, one in Chile and one in Garching.

At the beginning of the year, the old telephone system in Vitacura was upgraded to a new system. This upgrade was followed by a complete refurbishment of the internal ESO phone book application, providing consistent and up-to-date contact information. In the area of email and calendar services, the migration to Microsoft Exchange was completed, offering a shared calendar system to all ESO users. Training was provided to the users, and several flavours of the Outlook clients were deployed on Windows and Mac systems, as well as a web client. The new email system is fully integrated with the ESO information databases, ensuring that all relevant information such as the availability of people or fast resolution of email addresses, is provided.

The department improved the management of user accounts by centralising databases and optimising the account management lifecycle. This considerably simplifies user access to the different services. The virtualisation of computer services has also been a major topic, providing flexibility and agility for the deployment of servers by managing farms of virtual machines.

IT services provides effective and friendly support to all users. It has also recently triggered initiatives to improve information channels to the users: a new intranet IT news service includes information about incidents, service updates, tips and

tricks, as well as major updates. A series of IT talks was also initiated, which drew interest from a fair number of staff on topics like spam, email security and advanced Outlook features.

Software Engineering Department

The Software Engineering Department provides the development teams with software engineering services such as the environment and tools to support the software lifecycle, software quality assurance and control. The department is also in charge of integrating software modules and preparing and validating releases before they are delivered to the customer.

The Software Engineering Department provides support to all main software development projects of the organisation, including VLT and instrumentation software, data flow software, ALMA, and the E-ELT. One of the major projects of the department during the year was the deployment of the JIRA issue tracking system for the support of multiple projects. The deployment involved the migration of a large database of existing problem reports, mostly for the VLT and data flow software, which had been based on Remedy for over a decade. The new JIRA system was turned on practically overnight and has been very quickly adopted by the users.

Several versions of the VLT software have been completed and work has started for the preparation of the latest VLT software release, VLTSW 2013, which will be based on a 64-bit version of the scientific Linux operating system. A project was initiated for the refactoring of the VLT control model. The new test infrastructure for the VLT software will be based on a mix of virtual machines, physical machines, and hardware components like local control units, and will provide better flexibility than the current, hardware-based, version control management (VCM) system.

Throughout the year, testing services for the data flow software components for the ALMA release 9 series were provided. In support of the E-ELT project, a Windows-based development environ-

ment and LabView quality assurance tools were further developed. The department also started activities for the evaluation of software quality assurance methods for programmable logic controller (PLC)-based development. Software quality assurance activities for the support of PLCs for ESO instruments were initiated, with participation in the ESO working group on evaluation of PLC technology as a standard control system, and by gaining exposure to PLC technology.

Control and Instrument Software Department

The Control and Instrument Software Department (CIS) is responsible for the design, implementation and maintenance of control software for the VLT, VLTI and their instruments as well as ALMA and the E-ELT. Most of the time spent on VLT/VLTI software is dedicated to the development of control software for the new facilities being added to the telescopes.

At the beginning of the year, the department was structured into three groups: High-Level Control and Architecture, Hardware Control, and Real-Time and Instrumentation Development and Support group. Throughout the year, the activity of the department focussed on work for the VLTSW release, VLT instrumentation development and support, E-ELT prototyping activities, and ALMA support.

All Paranal telescopes have been upgraded to the VLTSW 2011 release, while development has started for the 2013 release. The department has been involved in projects for the proactive management of technological obsolescence in Paranal, participating in the development of a plan and working in collaboration with Paranal and TEC engineering teams in the M1/M3 cell electronics upgrade.

A major prototyping activity took place in the E-ELT software for the local supervision of the dome and main structure, demonstrating the use of state analysis from the Jet Propulsion Laboratory (JPL). At the same time, a lot of work has been done for the implementation of the control software for the M1 and M5



Testing the WS software at MPE (left), GRAVITY cryostat (right).

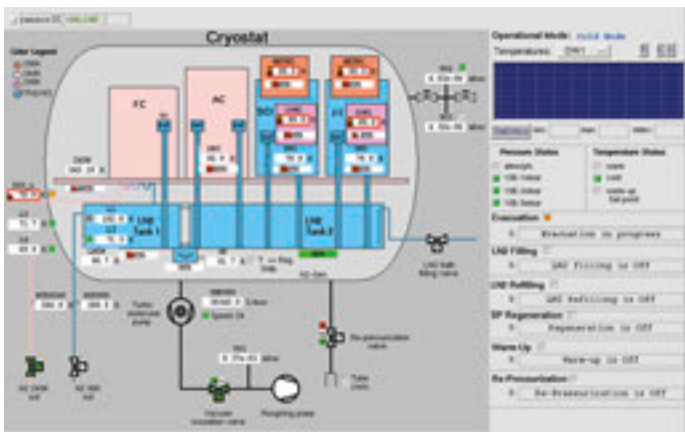

GRAVITY cryostat user interface.

prototypes in Garching Hochbrück, using LabView and Data Distribution Service (DDS) as the main software technologies. Support has been given to the PRIMA commissioning activities and the task force of the PRIMA Tiger Team by implementing all features requested with high priority. The PRIMA software has been demonstrated to be very stable and adaptable to the many requests received.

Developments with new PLC technologies have been initiated and, as part of collaborative work between the CIS and TCE departments of the Directorate of Engineering, the interface to the cryogenic controller developed by ESO using Siemens PLCs was implemented. The software has been integrated and tested at MPE in Garching.

Sort	Column	Constraint	Unit	Description	WCO
	SOURCE_ID			Observing source designation (J2000)	meta:src:meta-main
	NAMEOBJ			Running object number	meta:obj
	ALPHA_COORD		deg	Right ascension of barycenter in decimal degrees (J2000)	pos:ra:dec:meta-main
	DELTA_COORD		deg	Declination of barycenter in decimal degrees (J2000)	pos:ra:dec:meta-main
	X_ANGLE		pixel	Object position along x	pos:center:ax
	Y_ANGLE		pixel	Object position along y	pos:center:ay
	FLAG_NMCC			Bad region flag in 0 for bad region (bad instruments: T)	meta:code
	REV		flag	Obscure redacting (Rev-V) based on (original: 0 or 1) (Rev-V: null: meta)	phys:observation:ps

Catalogue facility query page.

In the area of ALMA, the software used for ALMA Early Science has proved to be stable and reliable. Progress has been made on the tests for the new bulk data system, with a view to employing it in operations following tests in Chile in the first half of 2013.

Data Flow Infrastructure Department

The Data Flow Infrastructure Department (DFI) is responsible for the design, implementation and maintenance of all the data flow system software components, which are critical for the end-to-end operation of the VLT, VLTI, VISTA, VST and some of the La Silla telescopes. The department also participates in the development of some of the ALMA data flow components.

This year, following several years of planning and development, the DFI has successfully deployed version 3 of the Phase 2 tool chain to all telescopes at Paranal. This deployment included the proposal preparation tool (P2PP), the service and visitor mode observing tools (OT, vOT), the VIMOS MaskTracker and the new night log tool. The main feature of this release is the support for scheduling containers (groups, time links, concatenations of observing blocks) that allow PIs to express complex, long-term observing strategies and comprehensive and highly automated night reporting.

Another major achievement has been the completion of the ESO Catalogue Facility. This is intended to support the submission and scientific exploitation of astronomical catalogues that result from ESO observations, first and foremost from the ESO Public Surveys, but also from ESO Large Programmes and from other projects which result in the generation of catalogue-type information based on ESO observational data. The European scientific community of astronomers at large is the primary target user group that benefits from this project in terms of data access and search capabilities. The PIs for the survey projects will interface with ESO through the catalogue facility for the delivery of catalogue data products. The archive researchers will use the catalogue query interface which represents the public interface to the catalogue facility from which the user will be able to query and access catalogue data. Powerful query and data visualisation capabilities, comparable with other astronomical data archives serving similar data, are a key success factor in becoming the primary access point for ESO Public Survey data.

Pipeline Systems Department

The Pipeline Systems Department is responsible for the design, implementation and maintenance of the data processing and numerical software components that are critical for the end-to-end operations of the ESO data flow systems of the VLT, VLT1, survey and La Silla telescopes, as well as ALMA. This includes the common pipeline library, the instrument pipelines, the ALMA/CASA

data reduction software and the exposure time calculators.

In April, the last official release of Munich Image Data Analysis System (MIDAS) was announced to the user community. Developments for MIDAS spanned more than 30 years (Ballester & Peron, 2012, *The ESO Messenger*, 148, 52). The system was the foundation of the data reduction processes for the VLT first light in 1998 and for the first instruments of the VLT until the early 2000s when the development of pipelines started to be based on the common pipeline library.

A major area of development for the department during the year was high-performance computing, which was at the core of both release 4 of the CASA package that is used for the processing of ALMA data, and release 6 of the common pipeline library, which was deployed on all Paranal telescopes in April.

Development of data reduction pipelines for all VLT instrumentation is a major activity of the department, and the KMOS pipeline was commissioned at Paranal in November.

In the area of Reflex scientific workflows, tutorials were presented to users at the ADA-VII Astronomical Data Analysis conference, and during a tutorial workshop at ESO in October. With the involvement of scientific users, new workflows were prepared for release to include including FORS spectroscopy, VIMOS IFU, and UVES-FLAMES data reduction.

This picture shows Barnard 59, part of a vast dark cloud of interstellar dust called the Pipe Nebula. This new and very detailed image was captured by the Wide Field Imager on the MPG/ESO 2.2-metre telescope at the La Silla Observatory.





Administration

The image in the background shows the start of construction of the new Headquarters extension in January 2012. The artist's rendering below envisages how it will look when completed towards the end of 2013.



For the second year, the Finance Department has set up ESO's annual accounts under the IPSAS norms (International Public Sector Accounting Standards). The financial statements for 2011 received an audit certificate and were approved by Council. These were the last steps necessary for full IPSAS compliance. The department also made arrangements to secure the cash situation over the construction period of the E-ELT project.

Several changes in the Procurement Department were implemented in order to improve the service to the internal customer. Training and workshops were given at all sites, best practices made available and lead times published in order to further improve the quality of input and the transparency of the procurement process.

After the successful two-day industry event at the Allianz Arena and a series of meetings with industry, the preparatory phase for the E-ELT dome and main structure procurement was concluded.

The construction of the ESO Headquarters extension started in January. It consists of an office and conference building as well as a technical building, connected by a bridge to the existing

structure. The technical building is especially designed to accommodate the instruments for the E-ELT. Completion of construction is scheduled for autumn 2013.

ESO participated in nine EU Framework Programme projects. Engagement with ASTRONET, RadioNet and OPTICON projects continues. These are the most important networking projects of the European scientific community for the preparation of future scientific and infrastructural developments in astronomy. ESO welcomes the growing number of Marie Curie Fellows, and will continue encouraging young scientists to apply to ESO under the new Marie Skłodowska-Curie Scheme as part of Horizon 2020.

ESO reached an important milestone in providing the highest level of security to all data in its possession by launching its new data classification policy. The risk management and compliance procedures of ESO were further enhanced. As part of that development, ESO reviewed its risk on its assets and concluded a tender for general insurance brokerage services.

In terms of safety, ESO conducted a comprehensive overhaul of all its safety

manuals for the Headquarters building and the observatories, as well as the procedure related to the conformity assessment of equipment. Intense communication efforts were made to apply the contents in operations and projects. Safety advised on the various aspects of health, safety and environment preservation in a large variety of projects, ranging from new buildings, scientific equipment and to scientific infrastructure projects.

Safety — in conjunction with the respective departments — also brought the safety procedures of the Santiago premises more in line with Garching. All the inspections that were carried out, while revealing minor areas of potential improvement, indicated a good standard of safety and a high level of safety commitment of the staff.

The administrative information system (ERP) was upgraded to utilise web services, thus allowing easy access for all users to relevant information via the Employee Self Service module. The system now also provides a common procurement platform for ALMA operations in Chile, streamlining the administrative processes between ESO and its partners.



On 11 June 2012 a ceremony took place at ESO's headquarters to mark the laying of the foundation stone of the extension to the ESO Headquarters building. The President of the ESO Council, Xavier Barcons (second right), the ESO Director General, Tim de Zeeuw (right front), ESO Headquarters extension project manager, Christoph Haupt (second left), and the mayor of the town of Garching, Ms Hannelore Gabor (left front) are seen.

Finance and Budget

Financial Statements 2012

Accounting Statements 2012 (in € 1000)

Statement of Financial Position	31.12.2012	31.12.2011
Assets		
Cash and cash equivalents	6 342	18 150
Inventories, receivables, advances and other current assets	34 313	61 954
Non-current assets	1 047 302	973 832
Total Assets	1 087 957	1 053 936
Liabilities		
Short-term borrowing	13 002	—
Payables, advances received and other current liabilities	62 257	40 709
Non-current liabilities	394 756	332 192
Total Liabilities	470 015	372 901
Accumulated surpluses/deficits	681 035	858 522
Pension fund loss/gain	-2 998	—
Other changes in net assets	-39 058	235
Net surplus/ deficit for the year	-21 037	-177 722
Total Net Assets	617 942	681 035
Total Liabilities and Net Assets	1 087 957	1 053 936

Statement of Financial Performance	01.01.– 31.12.2012	01.01.– 31.12.2011
Operating Revenue		
Contributions from Member States	132 690	131 487
Contributions to special projects	17 299	13 744
In kind contributions	1 313	15 651
Sales and service charges	3 808	3 818
Other revenue	530	2 025
Total Operating Revenue	155 640	166 725

Operating Expenses		
Installations and equipment	5 594	27 406
Supplies and services	54 805	40 937
Personnel expenses	78 527	223 662
Depreciation of fixed assets	43 087	49 237
Other operating expenses	459	907
Total Operating Expenses	182 472	342 149

Net surplus/deficit from operating activities	-26 832	-175 424
Financial revenue	1 506	2 620
Financial expenses	1 297	4 918
Net surplus/deficit from financial activities	209	-2 298
Non periodic and extraordinary revenue	5 586	—
Non periodic and extraordinary expenses	—	—
Net surplus (deficit) from non periodic and extraordinary activities	5 586	—
Net surplus/deficit for the period	-21 037	-177 722

* For information only: Considering full ratification from Brazil and additional income from ten Member States (out of 14) already formally engaged in the E-ELT supplementary programme in December 2012.

Cash Flow Statement	2012	2011
Cash Flow		
Net receipts	166 154	163 760
Net payments	-190 964	-196 469
Net cash flow from operating activities	-24 810	-32 709
Net cash flow from financing activities	13 000	—
Net cash flow =	-11 810	-32 709
Net decrease in cash and cash equivalents		

Budgetary Reports 2012 (in € 1000)

Income Budget	Budget	Actual
Contributions from Member States	165 258	133 119
Income from third parties and advances received	18 161	30 306
Other income	5 313	3 779
Consolidated entities	796	636
Total Income Budget	189 528	167 840

Payment Budget	Budget	Actual
Programme	106 678	83 768
Operations	64 745	63 459
Science support	8 640	8 535
Cross-directorate functions	39 101	34 976
Predicted payment delays	-3 000	—
Financing cost	25	18
Consolidated entities	617	509
Total Payment Budget	216 806	191 265

Budget for 2013 (in € 1000)

Income Budget	Approved	with E-ELT*
Contributions from Member States	135 541	201 156
Income from third parties	14 161	14 161
Other income	1 033	1 183
Consolidated entities	568	568
Total Income Budget	151 303	217 068

Payment Budget	Approved	with E-ELT*
Programme	69 273	70 389
Operations	71 343	71 343
Science support	8 322	8 322
Cross-directorate functions	43 885	43 885
Financing cost	155	56
Predicted savings / payment delays	-7 720	-7 720
Consolidated entities	568	568
Total Payment Budget	185 826	186 843

The External Auditors, Tribunal de Contas de Portugal¹, have expressed their opinion that the financial statements for 2012 give a true and fair view of the affairs of the Organisation.

The accounting statements for 2012 show a negative result of –21.0 million euro. This result arises principally from the increase in the provision for retirement benefits at the closing date, following the outcome of the actuarial study of the shared CERN/ESO Pension Fund at 31 December 2012. The net employer costs for the year appear under personnel expenses. This year the presentation of the actuarial loss has been changed. In accordance with the IPSAS standards it was recognised directly in the Statement of Financial Positions, whereas in 2011 it was included in the personnel expenses for the year. The net assets of the Organisation at 31 December 2012 amount to 617.9 million euro.

The negative cash flow from operating activities of –24.8 million euro in 2012 reflects the planned excess of payments over received income during the financial year. The main payments were for ALMA construction and for the Headquarters extension building. Short-term borrowing of 13 million euro was taken up to cover financing needs, resulting in an overall cash flow of –11.8 million euro. The cash position at 31.12.2012 was 6.3 million euro. (All borrowing was repaid by the end of April 2013.)

The budget for 2013 was approved by the ESO Council in December 2012. The approved 2013 payment budget amounts to 185.8 million euros. It covers the remaining commitments for the ALMA construction and includes a budget provision for the start of E-ELT construction activities, subject to the approval of the E-ELT construction phase by the ESO Council during the course of the year.

The 2013 approved income budget amounts to 151.3 million euro. It includes the regular contributions from the ESO European Member States, income from third parties and partners, and other income. No additional income from either the existing Member States or from Brazil as a new Member State has been considered. The column “with E-ELT” shows the expected income assuming the approval of the E-ELT construction phase by the ESO Council and the full ratification from Brazil during the course of the year.

¹ Antonio José Avérous Mira Crespo (Member of the Portuguese Court of Auditors), Maria da Luz Carmezim (Head of Audit Department) and Antonio Pombeiro (Senior Auditor).



La Silla, ESO's first observatory — still one of the premier ground-based observatories in the world.

Human Resources



The principal activities of the Human Resources Division (HR) during the past twelve months have concerned:

- HR strategy policy and planning
- Recruitment and selection
- Learning and professional development
- Employee relations and communications
- Occupational health and welfare and Social Security
- HR advice and administration

HR strategy policy and planning

As announced and presented to the Finance Committee and Council in 2011, an engagement survey was rolled out in Garching and Chile. A response rate of 65% was reached and the overall results of the survey were presented to the ESO management and to all staff. Feedback and Division-specific actions were presented to their teams by the respective Director and/or Division head. Divisional and departmental meetings took place in order to provide feedback, in particular regarding: leadership, delegation of authority, information, communication, performance management and career development.

Following those meetings, a global action plan was developed by ESO management and presented to all staff in June. HR-related matters were taken up immediately and this led to the following activities:

1. Release of the ESO People Policy in June

This document, available on the ESO homepage, sets out ESO's policy on matters regarding working together effectively, sharing responsibility, treating people with proper respect, and finding the right work-life balance and is termed the ESO Way.

2. Performance management

HR has reviewed the annual performance review process. A new performance management and professional development model and associated process have been developed. The ESO management has approved the draft concept and a validation through

the Staff Association and unions, as well as through various working groups in Garching and Chile, has taken place. The performance review working group consists of members of the ESO middle management. The initial results regarding self-appraisal, how to set SMART (Specific, Measurable, Achievable, Relevant, Time-bound) objectives, improving staff performance in the case of underperformance, and how to deal with a disagreement during and after the annual performance review, were immediately implemented in the 2012 performance review process. HR then provided presentations and training to supervisors in September. These training sessions were welcomed by the supervisors, who then had the opportunity to share experience, resulting in constructive comments and feedback. By the end of 2013, the approval of a final review and the settlement of all foreseen amendments of performance management procedures is expected. HR will then run training sessions from May to August 2013 in order to train staff and managers. The launch of the new processes will take place in September 2013.

3. Competency framework

In May, ESO's existing competency framework was re-worked by an external consultant, a group of nine staff members and HR advisors, in order to improve its applicability to performance reviews and recruitment processes, and to achieve a closer link with learning and development activities. Following the review by two working groups in August, one in Garching and one in Chile, the comprehensive draft competency framework is in its final stages of completion. The updated version will be provided to the management team and subsequently to the staff representatives by the end of January 2013.

4. Code of Conduct

In close interaction with ESO management and staff representatives, a Code of Conduct has been developed to ensure a shared appreciation of ESO ethics and values and their influence on working practices with regard to integrity, commitment, collaboration,

accountability and continued development. The Code of Conduct describes the basic standards of expected behaviour in support of ESO's mission for excellence and professionalism, fairly and legally. It will be released in March 2013.

5. 360° feedback reviews for supervisors and managers

The main aim of implementing a 360° feedback review is to help supervisors and managers to reflect in a structured way on their leadership style, identifying strengths and weaknesses and defining development plans where there are deficits, and including consistent follow-up. The revised competency framework (see above) will form the basis for the 360° questionnaire. The basic concept for 360° feedback was finalised at the end of June and was presented to the ESO management and staff representatives in July. In line with the implementation of the competency framework, it was further developed in detail and will be implemented in Garching and Chile between April and June 2013.

6. Further activities

Initial concepts were developed regarding possible flexible working time and core presence in Garching and Vitacura, and the implementation of the process for the publication of internal vacancies to foster career development and job rotation. A review of the definition and description of professional and managerial career paths has also been started.

Project-oriented matrix management

Following the staffing review in 2011, an overall staffing plan was designed and implemented to allow for a project-oriented matrix management scheme to deploy staff efficiently and to meet the evolving demands of ESO. These implementations — as well as the accompanying restructuring of the Directorate of Programmes and the Directorate of Engineering — led to some open questions with regard to conducting projects in a uniform way, as well as the implications for collaborative relations between functional managers and project managers

and their roles and responsibilities. Thus it was decided to hold a workshop involving functional managers from all Directorates (i.e., department and group heads) as well as project managers across ESO — involving approximately 80 staff — to be facilitated by an external consultant. The aim of this interactive workshop is to develop a common understanding of high-level principles and to describe and formalise their working relations. In close interaction with the Director of Engineering, HR has set up this workshop, which will take place by the end of January 2013.

Recruitment, selection and reassignment

During the year, 26 vacancy notices were published, prompting a total of 1195 applications. The numbers for recruitment campaigns completed according to contract type were as follows:

Contract Type	No. of Campaigns	No. of Applications
Staff members	15	342
Local staff members	10	624
Fellows	1	229

All positions were advertised on the ESO website. For international positions, notifications were sent to all members of Council, the Finance Committee and the delegates of other ESO Committees, as well as to national and international research centres and observatories. In addition, prominent advertisements for

selected positions were placed in appropriate specialist publications and on recruitment web pages. All ESO advertisements contain a statement regarding our commitment to equal opportunities.

Within the ESO Fellowship Programme, six applicants were selected with duty station in Chile and six for Garching. Furthermore, six candidates were awarded Studentships in Europe and eight were awarded in Chile.

Three staff members were temporarily transferred to Chile to support the commissioning activities for ALMA construction and the Joint ALMA Observatory. In addition, 22 members of personnel were reassigned internally due to operational reassignment or at their request.

Learning and professional development

A comprehensive training programme was offered and organised in Garching and Chile. During the year a total of 279 members of personnel attended training organised by HR.

Major pieces of work included the area of 360° feedback and the matrix workshops, the identification of possible service providers, their briefing, development of the respective scope of work, and the running of two-phase price inquiries. A coaching concept and guideline is in preparation to cover development needs resulting from the 360° feedback. Major progress was achieved with the Fellow Development Programme to be rolled out in 2013.

A training catalogue has been created that provides an overview of all courses developed and offered over the last four years. The experiences from this catalogue enabled HR to focus its efforts on the delivery of the following courses: Conflict Management; Time Management; The ESO Management Development Programme; language training, a comprehensive MS Office training programme and the delivery of a fair treatment, courtesy and respect policy training for ESO's managers and International Staff Committee. Training within the EIROforum framework came to an end with the delivery of a last project management training course attended by ESO Fellows. The Leadership Programme was also completed early in the year.

Employee relations and communications

Regular consultation and interaction with the International Staff Committee and the unions in Chile have continued. A total of 18 meetings in Garching and Chile were held in order to inform, discuss and exchange opinions in the areas of organisational development, policy amendments, regulations, health and family working groups and training actions.

In November, collective bargaining with the La Silla and Paranal unions took place. Meetings started in early November and extended towards the deadline date contemplated in the previous collective contract. The new collective contract for the period December 2012 to November 2014 was signed on 30 November. The key aspects of the new collective contract are: no real increase in salary; adjusted compensations for the VLTI manager, telescope coordinator, and telescope, instruments and software start-up staff; adjustments of the official holiday calendar; increase in the number of carry-over leave days; regulations regarding protection during pregnancy and parental leave; adjustment of special leave after parental leave; extension of the suspension period of allowances and guaranteeing the payment of allowances in cases of pregnancy and maternity leave.

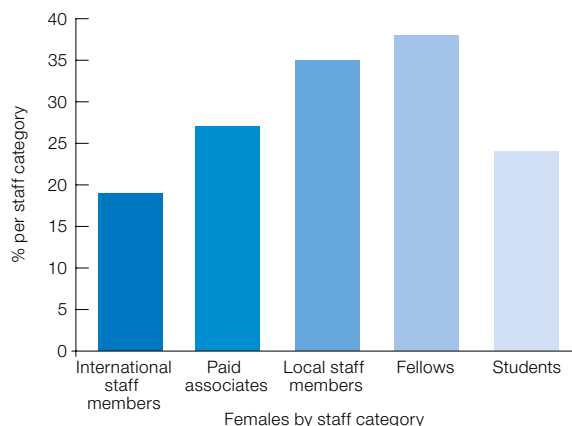

In 2012, the number of female staff represented 23% of the overall count. The breakdown by staff category is shown.

During the course of the year, three Rehabilitation Boards examined cases concerning incapacity, illness and procedural actions. Two Advisory Appeal Boards were appointed and their substantiated recommendations were followed by the Director General.

Collaboration and representation of HR

ESO HR has participated in monthly meetings of the ALMA Human Resources Advisory Group (HRAG) and contributed in particular to: the release of the HRAG terms of reference, giving advice in union matters and staff transition from construction to operation, the result of the salary survey for ALMA local staff members, the appointments of managers and the development of policies and procedures.

HR also organised and participated in two meetings of the Tripartite Group, which dealt mainly with the development of the CERN Pension Fund and Staff Regulations, the annual review of remuneration and allowances, salary adjustments, the results of the engagement survey and staff policies.

One meeting of the EIROforum HR thematic working group took place in February 2012 and some of the issues discussed dealt with the HR competency framework and training events for researchers in areas of project management and presentation skills.

Health and welfare and social security

A working group, consisting of representatives of CERN management, ESO management and the CERN Pension Fund, continued to seek an optimal solution for the calculation and payment of contributions and pensions for newly recruited ESO staff on the basis of effective ESO salaries. Several meetings took place and promising developments and results were achieved. A final decision on this matter is expected by the end of March 2013.

Staff members by nationality — 31 December 2012.

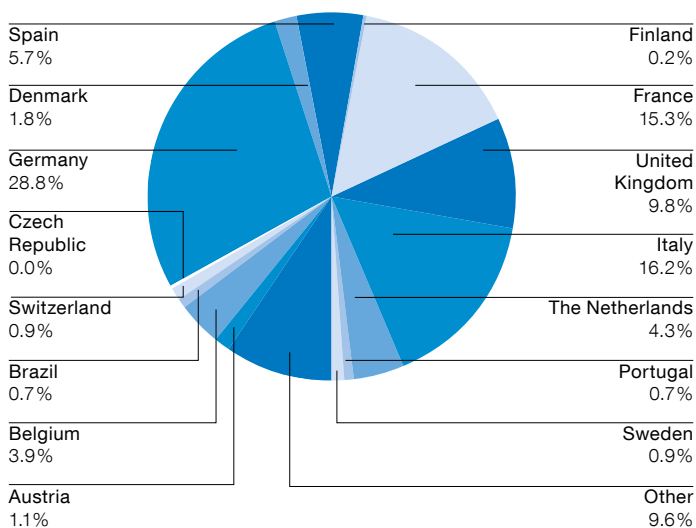

Following the changes in the regulations of the CERN Pension Fund, the retirement age for ESO's new staff has risen from 65 to 67 years, and the contribution and benefit formulas have been amended. An internal review and the decision of Council in December resulted in the adjustment of staff contributions to the Pension Fund, effective 1 January 2013, in order to restore and maintain the ratio between contributions and pension benefits.

During the past twelve months several amendments within the health insurance scheme took place to adjust and update the medical coverage to the needs and/or to developments in health care in the Member States. The contribution scheme will be stable for 2013.

HR advice and administration

As part of the comprehensive and service-oriented contract administration duties, HR also handles a wide spectrum of personnel-related activities. As an integral part of this service, a variety of pertinent documents and circulars have been produced and issued.

Staff departures

The departures of staff this year fell into the following categories:

Reasons	Staff member	Local staff member
Resignation	6	7
Expiry of contract	8	0
Retirement	3	3
Mutual agreement	4	1
Total	21	11

List of Staff

As of 31 December 2012

Office of the Director
General

Tim de Zeeuw

Directorate of
Engineering

Michèle Péron

	Administration Division	Human Resources	Software Development Division	Technology Division
	Patrick Geeraert	Roland Block	Michèle Péron	Roberto Tamai
Mary Bauerle	Patricia Adriaizola	Angela Arndt	Roberto Abuter	José Antonio Abad
Laura Comendador	Andrés Arias	Mercedes Chacoff	Luigi Andolfato	Matteo Accardo
Frutos	Juan Carlo Avanti	Amal Daire	Javier Argomedeo	Gerardo Avila
Fernando Comeron	Katalin Baltayne	Nathalie Kastelyn	Andrea Balestra	Pablo Jose Barriga
Gabriela Gajardo	Korompay	Katjuscha Lockhart	Pascal Ballester	Campino
Nikolaj Gube	Jean-Michel Bonneau	Anna Michaleli	David Bargna	Domenico Bonaccini
Priya Nirmala Hein	Renate Brunner	Maria Angelica Moya	Thomas Bierwirth	Calia
Isolde Kreutle	Marcela Campos	Betül Özener	Reynald Bourtembourg	Henri Bonnet
Elena Llopis	Karina Celedon	Mauricio Quintana	Blanca Camucet	Roland Brast
Diego Rioseco	Claudia Silvina Cerda	Rosa Ivonne Riveros	Alessandro Caproni	Martin Brinkmann
Massimo Tarenghi	Alain Delorme	Francky Rombout	Sandra Maria Castro	Enzo Brunetto
Jane Wallace	Evelina Dietmann	Marcia Saavedra	Alberto Maurizio Chavan	Bernard Buzzoni
	Andrea Dinkel	Nadja Sababa	Gianluca Chiozzi	Emanuela Ciattaglia
	Sabine Eisenbraun	Heidi Schmidt	Mauro Comin	Ralf Dieter Conzelmann
	Willem Eng	Maria Soledad Silva	Livio Condorelli	Sebastian Deiries
	Rebonto Guha	Roswitha Slater	Paula Cristina Correia	William Zinsmeyer
	Leonardo Guzman	Lone Vedso Marschollek	dos Santos	
	Robert Hamilton		Claudio Cumani	Nicola Di Lieto
	Christoph Haupt		Robert Donaldson	Canio Dichirico
	Charlotte Hermant		Dario Dorigo	Martin Dimmler
	Kristel Jeanmart		Philippe Duhoux	Michel Duchateau
	Georg Junker		Sylvie Feyrin	Christophe Dupuy
	Katarina Kiupel		Vincenzo Forchi	Toomas Erm
	Hans-Jürgen Kraus		Robert Frahm	Siegfried Eschbaumer
	Ignacio López Gil		Armin Gabasch	Michael Esselborn
	Joana Catarina		César Enrique García	Gerhard Fischer
	Lourenco Correia		Dabó	Christoph Frank
	Qiao Yun Ma		Bruno Gilli	Fernando Gago
	Maria Madrazo		Alain Gilliotte	Paolo Ghiretti
	Alessandro Martis		Percy Glaves	Domingo Gojak
	Christian Muckle		Justo Antonio Gonzalez	Ivan Maria Guidolin
	Hélène Neuville		Villalba	Serge Guniat
	Claudia Ober		Thomas Grudzien	Ronald Guzman
	Ester Oliveras		Carlos Guirao Sánchez	Collazos
	Ernesto Orrego		Florian Heissenhuber	Wolfgang Hackenberg
	Enikő Patkós		Bogdan Jeram	Andreas Haimerl
	Thomas Penker		Yves Jung	Volker Heinz
	Leonel Pizarro		Robert Karban	Guy Hess
	Fabian Reckmann		Mario Kiekebusch	Renate Hinterschuster
	Jürgen Riesel		Maurice Klein Gebbinck	Ronald Holzöhner
	Elke Rose		Jens Knudstrup	Georgette Hubert
	Johannes		Nicholas Charles	Gerd Jakob
	Schimpelsberger		Kornweibel	Paul Jolley
	Guido Serrano		Basilio Kublik	Andreas Jost
	Erich Siml		Uwe Lange	Dimitrios Kalaitzoglou
	Alexandra Specht		Simon Lowery	Lothar Kern
	Albert Triat		Lars Kristian Lundin	Jean Paul Kirchbauer
	Arnout Tromp		Alisdair Manning	Barbara Klein
	Florine Vega		Stewart McLay	Franz Koch
	Maritza Vicencio		Andrea Modigliani	Maximilian Kraus
	Michael Weigand		Christophe Moins	Samuel Lévêque
	Yves Wesse		Yuka Morita	Steffan Lewis
	Irmtraud Zilker-Kramer		Michael Naumann	Paul Lilley
			Ralf Palsa	Jean-Louis Lizon à
			Moreno Pasquato	LAllemand
			Martine Peltzer	
			Werther Pirani	

Directorate of Programmes

Adrian Russell

Roberto Gilmozzi
Samantha Milligan
Valérie Saint-Hilaire**ALMA Construction Division**

Wolfgang Wild

Christian Lucuix
Juan Antonio Marrero Hernandez
Michael Müller
Lothar Noethe
Lorenzo Pettazzi
Thomas Pfrommer
Cristian Pontoni
Marco Quattri
Jutta Quentin
Andrew Rakich
Roland Reiss
Robert Ridings
Stefan Sandrock
Babak Sedghi
Christian Soenke
Mirko Todorović
Sebastien Tordo
Arno Van KesterenEric Allaert
Gareth Aspinall
Claudio Cabrera
Massimiliano Camuri
Juan Carlos Echaniz
Petrus Gerhardus Fourie
Pieter Hekman
Hervé Kurlandczyk
Robert Alexander Laing
Massimiliano Marchesi
Pascal Martinez
Rainer Mauersberger
Ferdinand Patt
Silvio Rossi
Erich Schmid
Stefano Stanghellini
Donald Tait
Gie Han Tan
Eugenio Ureta
Gianluca Verzichelli
Pavel Yagoubov
Elena Zuffanelli**Instrumentation Division**

Mark Casali

Emmanuel Aller
Carpentier
Fatme Allouche
Paola Amico
Robin Arsenault
Dietrich Baade
Paul Bristow
Iris Bronnert
Richard Clare
Klaas Johannes Dekker
Françoise
Delplancke-Ströbele
Frédéric Derie
Reinhold Dorn
Mark Desmond
Downing
Enrico Fedrigo
Gert Finger
Christoph Geimer
Andreas Glindemann
Juan Carlos González Herrera
Peter Hammersley
Norbert Hubin
Derek James Ives
Olaf Iwert
Lieselotte Jochum
Hans-Ulrich Käufel
Markus Kasper
Florian Kerber
Johann Kolb
Harald Kuntzschner
Paolo La Penna
Miska Le Louarn
Gaspare Lo Curto
Pierre-Yves Madec
Antonio Ramon
Manescau Hernandez
Enrico Marchetti
Leander H. Mehrgan
Serge Menardi
Manfred Meyer
Nicolas Muller
Luca Pasquini
Jérôme Paufique
Duc Thanh Phan
Jean-François Pirard
Suzanne Ramsay
Javier Reyes
Piero Rosati
Gero Rupprecht
Marc Sarazin
Christian Schmid
Markus Schöller
Ralf Siebenmorgen
Jörg Stegmeier
Josef Strasser
Stefan Ströbele
Marcos Suárez Valles
Elise Vernet
Joël Daniel Roger
Vernet
Julien Woillez**E-ELT Division**

Alistair McPherson

Mustafa Basbilir
Bertrand Bauvir
Marc Cayrel
Philippe Dierickx
Peter Murray Gray
Bertrand Köhler
Javier Marti Canales
Katia Montironi
Dominik Schneller**Directorate of Operations**

Andreas Kaufer

La Silla Paranal Observatory

Andreas Kaufer

Sergio Abadie
Margarita Acuña
Claudio Agurto
Bernardo Ahumada
Yazan Al Momany
Javier Alarcon
Jaime Alonso
Fernando Alvarez
José Luis Alvarez
Nicolas Alvarez
Iván Aranda
Juan Pablo Araneda
Ernesto Araya
Pablo Arias
Oriel Alberto Arriagada
Karla Aubel
Francisco Azagra
José Báez
Pedro Baksai
Rogelio Bascunan
Juan Beltran
Guillaume Blanchard
Israel Blanchard
Henri Boffin
Carlos Bolados
Pierre Bourget
Stéphane Brilliant
Erich Bugueno
Francisco Cáceres
Luis Alejandro Caniguante
Michael Cantzler
Ruben Carcamo
Cesar Cárdenas
Mauricio Cárdenas
Arnaud Carlier
Giovanni Carraro
Duncan Castex
Roberto Castillo
Monica Castillo
Susana Cerda
Cecilia Ceron
Claudia Cid
Alex Correa
Alejandra Cortes
Claudio De Figueiredo Melo
Willem-Jan de Wit
Diego Del Valle
Alvaro Diaz
Reinaldo Donoso
Javier Duk
Christophe Dumas
Michael Dumke
Carlos Durán
Carlos Ebensperger
Cristian Elao
Cristian Esparza
Lorena Faundez
José Figueroa
Erito Flores
Juan Carlos Fluxa
Eloy Fuenteseca
Sergio GaeteDaniel Gaytan
Rodrigo Gesswein
Julien H. V. Girard
Philippe Gitton
Frédéric Yves Joseph Gonte
Leonardo González
Andres González
Sergio González
Javier Andres González
Jaime González
Patricia Guajardo
Carlos Guerra
Stéphane Guisard
Nicolas Haddad
Juan Pablo Haddad
Pierre Haguenauser
George Hau
Juan Pablo Henriquez
Cristian Herrera
Gerhard Hüdepohl
Rodrigo Huerta
Gerardo Ihle
Valentin Ivanov
Nestor Jimenez
Ismo Kastinen
Carlos La Fuente
Francisco Labraña
Octavio Lavin
Cedric Ledoux
Alfredo Leiva
Marcelo López
Fernando Luco
Felipe Mac-Auiliffe
Pedro Mardonos
Kiriako Markar
Christophe Martayan
Mauricio Martinez
Eduardo Matamoros
Dimitri Mawet
Angel Mellado
Alejandra Mena
Antoine Merand
Steffen Mieske
Lorenzo Monaco
Francisco Miguel Montenegro-Montes
Alex Morales
Sebastien Morel
Iván Muñoz
Julio Navarrete
Hernan Nievas
Rodrigo Olivares
Francisco Olivares
Jared O'Neal
Juan Osorio
Juan Carlos Palacio
Rodrigo Javier Parra
Ricardo Andrés Parra
Andres Parraguez
Diego Parraguez
Marcus Pavez

Directorate for
Science

Bruno Leibundgut

Data Management/
Operation

Martino
Romaniello

Eduardo Peña
Jorge Pilquinao
Juan Pineda
Andres Pino
Manuel Pizarro
Aldo Pizarro
Emanuela Pompei
Sébastien Poupar
Matteo Pozzobon
Andres Ramirez
Christian Ramirez
Claudio Reinero
Sridharan Rengaswamy
Claudia Reyes
Lidia Riffo
Miguel Riquelme
Leonel Rivas
Thomas Rivinius
Chester Rojas
Pascual Rojas
Cristian Romero
Rodrigo Romero
Felix Alberto Rozas
Francisco G. Ruseler
Fernando Salgado
Ariel Sanchez
Pierre Sansgasset
Jorge Santana
Ivo Saviane
Linda Schmidtreibich
Ricardo Schmutzer
Nicolas Schuhler
Frédéric Schuller
Alex Segovia
Fernando Selman
Waldo Siclari
Peter Sinclair
Nicolas Slusarenko
Alain Smette
Jonathan Smoker
Christian Spille
Michael Fritz Sterzik
Sandra Strunk
Thomas Szeifert
Richard Tamblay
Mario Tapia
Manuel Torres
Josefina Urrutia
Guillermo Valdes
Jose Javier Valenzuela
Karen Vallejo
Pierre Vanderheyden
Paulina Venegas
Enrique Vera
Sergio Vera
Jorge Vilaza
Zahed Wahhaj
Ueli Weilenmann
Luis Wendegass
Gundolf Wieching
Andrew Wright

Paola Andreani
Angelika Beller
Fabio Biancat Marchet
Andrew Biggs
Daniel Bramich
Stella-Maria
Chasiotis-Klingner
Carlos De Breuck
Nausicaa Delmotte
Maria Diaz Trigo
Danuta Dobrzycka
Adam Dobrzycki
Nathalie Francine
Fourniol
Wolfram Freudling
Monika Gotzens
Jonas Haase
Reinhard Hanuschik
Evanthia Hatziminaoglou
Michael Hilker
Wolfgang Hummel
Christian Hummel
Elizabeth Humphreys
John Lockhart
Vincenzo Mainieri
Stephane Marteau
Alberto Micol
Sabine Möhler
Palle Moller
Sangeeta Mysore
Mark Neeser
Nadine Neumayer
Isabelle Percheron
Dirk Petry
Francesca Primas
John Pritchard
Suzanna Randall
Marina Rejkuba
Jörg Retzlaff
Jesus Rodriguez Ulloa
Thomas Stanke
Felix Stoehr
Dieter Suchar
Lowell Tacconi-Garman
Elena Valenti
Mario Van Den Ancker
Eelco van Kampen
Ignacio Vera Sequeiros
Jeremy Walsh
Markus Wittkowski
Burkhard Wolff
Veronique Ziegler
Martin A. Zwaan

Rebeca Aladro
Alvaro Alvarez Candal
Mathias Andre
Manuel Aravena
Joana Ascenso
Daniela Barria
Amelia Maria Bayo Aran
Giacomo Beccari
Jean-Philippe Berger
Jérémi Boissier
Margherita Bonzini
Jutta Boxheimer
Gabriel Brammer
Joanne Breitfelder
Pamela Bristow
John Carter
Lars Lindberg
Christensen
Lodovico Coccatto
Luca Cortese
Gráinne Costigan
Silvia Cristiani
Joana Mafalda da Cruz
Carmo Martins
Timothy Davis
Bruno Dias
Guillaume Drouart
Paul Elliott
Eric Emsellem
Anja Feldmeier
Anna Feltre
Leticia Ferreira
Robert Fosbury
Caroline
Foster-Guanzon
Dimitri Gadotti
Roberto Galvan-Madrid
Herman Garrido
Stephan Geier
Neale Gibson
María Eugenia Gómez
Luis Goncalves Calcada
Oscar Alberto Gonzalez
Garcia
Florian Gourgeot
Rebekka Grellmann
Uta Grothkopf
Jason Harley Grunhut
Sylvain Guieu
Bitten Gullberg
Olivier Hainaut
Hans Hermann Heyer
Richard Hook
Renate Elisabeth Hoppe
Leo Huckvale
Gaitee Hussain

ALMA Joint Office/
Observatory

Mattheus Thijs de
Graauw

Rubén
Sánchez-Janssen
Christoph Saulder
Peter Scicluna
Raquel Yumi Shida
Rowena Sirey
Vernesa Smolcic
Loredana Spezzi
Jason Spyromilio
Christina Stoffer
Leonardo Testi
Svea Teupke
Grant Tremblay
Amy Tyndall
Paula Maria Fernanda
Urrutia-Viscarra
Sergio Vasquez
Laura Ventura
Pierre Vernazza
Maja Vuckovic
Jeffrey Franklin Wagg
Ke Wang
Roger Wesson
Michael West
Mark Westmoquette
Dominika Wylezalek
Fei Yan
Fei Zhao
Herbert Zodet

Robert Fosbury
(Emeritus
Astronomer)
Sandro D'Odorico
(Emeritus
Astronomer)

Andreas Andersson
Lundgren
Denis Barkats
Ravinder Bhatia
Paulina Bocaz
Paolo Gherardo Calisse
Itziar De Gregorio
Monsalvo
William Dent
Giorgio Filippi
Daniel Fulla Marsa
Diego Alex Garcia
Jorge Ibsen
Henderikus Jager
Rüdiger Kneissl
Stéphane Leon Tanne
Gianni Marconi
Gautier Mathys
Maurizio Miccolis
Theodoros Nakos
Lars Åke Nyman
Jose Parra
Evert Pauwels
Neil Matthew Phillips
David Rabanus
Armin Silber
Giorgio Siringo
Russell Smeback
William Snow
Baltasar Vila Vilaro
Eric Villard
Catherine Vlahakis
Nicholas Whyborn
Gert Tommy Wiklind

Right: It was decided as early as 1964, with the ESO activity increasing in Santiago, to acquire a *piéd à terre* in the city so that ESO would not have to rely on hotels. The purchase of the Guesthouse was completed in March 1965, and it was originally used as an administration office as well as a lodge for visitors. However, in the early 1970s the official ESO offices were moved to the new building in Vitacura, a few kilometres away in the city, allowing the Guesthouse to be used exclusively for the comfort and convenience of travel-weary astronomers and staff. As can be seen in these two photographs, the Guesthouse has managed to remain a constant in ESO's ever-changing life.





ESO/G.H. Hudepohlt (atacamaphoto.com)



ESO/G.H. Hudepohlt (atacamaphoto.com)

Organigram

As of 31 December 2012

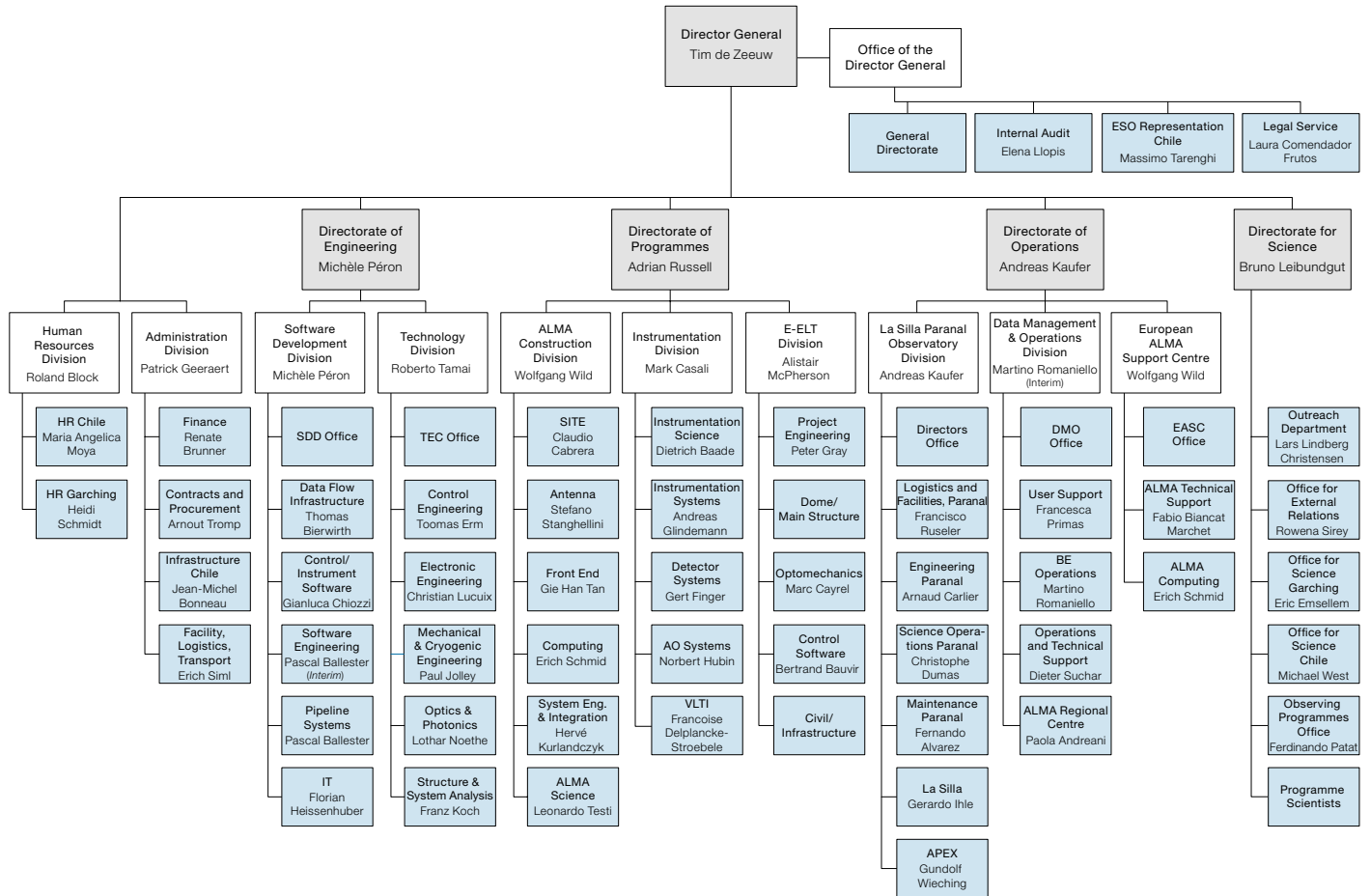

Left: The historical photograph, on top, shows the Residencia under construction at the end of 2000. The building materials have the same colour as the desert to help it blend into the landscape, and the central area of the Residencia is reminiscent of an amphitheatre. Today, as can be seen in the background image, the area is covered by a 35-metre-wide glass dome, which allows natural daylight into the building. Both the garden and the pool are designed to increase the humidity indoors, allowing staff some respite from the extremely arid conditions in one of the driest places on Earth.

Office of the Director General



Professor Tim de Zeeuw, Director General of ESO, speaks at a Gala event to mark the 50th anniversary of ESO. The event took place on the evening of 11 October 2012, in the Kaisersaal of the Munich Residenz in Germany. On the right, ESO's former Directors General are seen: Prof. O. Heckmann, Prof. A. Blaauw, Prof. L. Woltjer, Prof. H. van der Laan, Prof. R. Giacconi and Dr C. Cesarsky.

Legal Service

The Legal Service (LS) contributed to the preparation of Council and Finance Committee documents. It participated in meetings of the Council, Finance Committee, Tripartite Group, and the working groups on new Member States and on CERN Pension Fund matters. It assisted in the follow-up of issues concerning the ALMA Board and the ALMA Directors' Council (leading to the drafting of an ALMA Trilateral Agreement covering ALMA Operations, assistance during an environmental inspection visit, etc.).

The LS had high-level interactions with Member States and with potential new Member States involving the preparation of draft accession agreements, participating in informal discussions, etc.

All legal aspects connected to the E-ELT were also monitored by the LS. This included the follow-up of the administrative authorisations to be granted by the Chilean Government regarding the donation/concession of the land for the E-ELT and property rights issues, as well as environmental and safety matters. The LS also contributed to the discussions with Chilean electricity supply companies for the power supply for the E-ELT and La Silla.

Furthermore, the LS provided advice regarding immunity issues and the legal status of all ESO sites in cases of illegal mining activities, water and geothermal matters. Environmental aspects, accidents and safety issues were also reviewed by the LS. Support was provided on agreements, *Nota Verbale* and interactions with Chilean national and local authorities.

The LS assisted the ESO administration in the negotiations with the European Investment Bank and commercial banks to secure cash flow during the E-ELT construction. The LS contributed to the preparation of, and gave advice on, the ongoing sale of small ESO properties in Chile. The LS provided advice to contractors in many different legal areas such as compliance with Chilean labour or safety regulations; it supervised the procedure for the reimbursement of VAT; dealt with Chilean civil and labour lawsuits and provided legal assistance to the Headquarters Extension Project Office in the interactions with the general contractor, authorities and architects. The LS also played a major role in an arbitration procedure, where the final award fully supported ESO's position.

Advice was provided to Human Resources in the preparation of various agreements for the secondment of personnel; it prepared powers of attorney for ESO's personnel in Chile and delegations of author-

ity from the Director General to ESO managers; it assisted the management during the collective bargaining with the local staff and helped with internal appeals and with complaints in front of the Administrative Tribunal of the International Labour Organisation; and it helped with the update and review of the Staff Rules and Regulations, internal memoranda and administrative circulars as well as with CERN Pension Fund matters.

Additionally, the LS participated in negotiations and drafting of various agreements regarding the use of telescopes at La Silla by national institutes.

To mark the occasion of ESO's 50th anniversary, the LS was asked to update the ESO Basic Texts, a compendium of the founding documents and major agreements of ESO with its Member and Host States translated into all languages of ESO Member States. The books were handed over to the delegations in October.



The ALMA Directors' Council meeting was held at the National Astronomical Observatory of Japan in Tokyo from 17–18 February, with the participation of the directors of the three regional executives on behalf of East Asia, Europe and North America, and the Director of the Joint ALMA Observatory in Chile.

Chile Relations

The year 2012 saw ESO entering its 49th year of operations in Chile, a period that has been marked by excellent support and interest from all the different sectors of Chilean society.

It has become increasingly clear that Chile is transforming itself into a country with a strong interest in, and an active involvement with, worldwide astronomical research, with a perspective stretching back over the 50 years of its relationship with ESO, and with a forward-looking view anticipating the next half century. This interest in astronomy and the concomitant appreciation of ESO were clearly marked by the selection of Paranal as the site for the event where the Pacific Alliance Treaty was signed. The presence of four heads of state: Presidents Piñera, Humala, Santos and Calderón, as well as the King of Spain, ambassadors, and the foreign ministers of countries interested in becoming partners of the Pacific Alliance, marked a highlight for the visibility of ESO in Chile, with a significant impact in the press, on television and among the population in general.

The night spent in Paranal by President Piñera, when he observed Eta Carina, and the following night when President Calderón observed the full Moon, were particularly significant for their appreciation of the Chilean sky and the European telescopes. In addition to these important visits, the year will also be remembered for the visits of many other dignitaries and their delegations, such as:

- Carlos Pachá, member of the Brazilian President's team
- Congressmen from the Chilean Chamber of Deputies, Science Committee
- Senators Guido Girardi and J. P. Letelier
- Former President Alvaro Uribe (Colombia)
- Dr Riita Mustonen, Vice President for Research, Academy of Finland
- Chilean Head of Protocol, Ambassador James Sinclair
- Undersecretary for Tourism, Ms Jacqueline Plass
- Rectors from Finnish Universities
- German Federal Minister for Education and Research, Dr Annette Schavan
- Ambassador of Denmark in Chile, HE Lars Steen Nielsen

- Ambassador of Austria in Chile, HE Dorothea Auer
- Ambassador of Sweden in Chile, HE Eva Zetterberg
- Ambassador of France in Chile, HE Marc Giacomini
- Ambassador of Italy in Chile, HE Vincenzo Palladino
- Ambassador of the Czech Republic in Chile, HE Zdenek Kubanek
- Ambassador from the European Union, HE Rafael Dochao
- Delegation from CERN
- Danish Dark Cosmology Centre delegation
- President of Austria, Heinz Fischer and delegation (Vitacura, December)

The President of Austria, HE Heinz Fischer and his delegation did not have enough time in Chile to visit Paranal, but did visit Vitacura and expressed enormous interest in what ESO is doing.

ESO, in collaboration with other observatories in Chile, supported the Ministerio del Medio Ambiente (Ministry for the Environment) in completing and approving the new *norma lumínica* (light standards) which protects the sky in Regions II



The presidents of Chile, Colombia, Mexico and Peru met on 6 June at ESO's Paranal Observatory in the Chilean Atacama Desert, seeing at first hand the state-of-the-art telescopes and technology at ESO's flagship site. The presidents gathered at Paranal for the fourth Summit of the Pacific Alliance, at which the Alliance's Framework Agreement was ratified.

and IV so that astronomical observations can be continued under the best possible conditions.

The annual contribution that ESO provides, as part of the promotion of astronomical activities in Chile through the Joint Committee ESO-Government of Chile, once more identified serious projects that support different areas of astronomy: academic, outreach, supporting young astronomers and in helping meetings and SOCHIAS (the Chilean Astronomical Society). In parallel and in collaboration with its American and Japanese partners, funds were allocated through the Chilean National Commission for Scientific and Technological Investigations (CONICYT) as part of the ALMA collaboration.

As interest in Chile grows there is a continuing effort to present astronomy to the general public. The Saturday afternoon tours, both to La Silla and Paranal, have seen an increasing number of visitors, indicating the need to focus on this kind of activity. This is particularly pertinent following the start of ALMA operations and in anticipation of the E-ELT project. ESO has also collaborated with a government initiative that provides support, through mobile observatories, for the dissemination of astronomical culture in the country.

Top: President Sebastián Piñera of Chile and his wife, Cecilia Morel, in the Paranal control room on 5 June 2012. In the background we see (from left): the Director of the Observatory, Andreas Kaufer; the President of the ESO Council, Xavier Barcons; the Director General of ESO, Tim de Zeeuw; ESO's Representative in Chile, Massimo Tarenghi; and ESO astronomer Fernando Selman, from Chile. President Piñera participated in observations of the Carina Nebula with the VST.

Middle: On the visit to ESO's Paranal Observatory on 6 June 2012, the King of Spain had lunch with the Presidents of Chile, Colombia, Mexico and Peru. The Presidents were at Paranal for the Fourth Summit of the Pacific Alliance. The King came to Paranal on the last day of his official visit to South America, during which he visited Brazil and Chile, before returning to Spain.

Bottom: On 6 December 2012 the Federal President of the Republic of Austria, Dr Heinz Fischer, and his wife Margit Fischer, visited ESO's premises in Santiago, Chile. The President was accompanied by Dorothea Auer, Austrian Ambassador to Chile, and Friedrich Faulhammer, Secretary General of the Austrian Ministry of Science and Research.



International Relations

Relations with Member States, potential new Member States and other activities

As part of the process of preparing the approval of the E-ELT construction proposal, ESO maintained a very close and active relationship with its Member States. This is why, during the course of the year, representatives of ESO visited several ministries in the Member States and hosted national delegations to discuss plans and priorities. These visits provided the opportunity for individual discussions with ESO on specific issues and concerns, in particular about funding for the E-ELT, seeking to develop a better understanding of the Member States' requirements and constraints, and to provide any information and support required by them.

There continues to be a steady flow of enquiries about the costs and implications of membership of the Organisation, resulting in ESO making numerous informal contacts with different countries inside and outside Europe concerning potential membership. This process included visits by representatives of several potential candidate Member States to both ESO Headquarters and ESO's observatories in Chile, as well as visits by ESO representatives to a number of potential candidate Member States.

At the United Nations Committee on the Peaceful Uses of Outer Space, where ESO has permanent observer status, ESO continued to be part of Action Team 14, which is responsible for preparing a comprehensive set of recommendations regarding the detection, monitoring, and information and warning system, as well as possible mitigation efforts, for dealing with the potential Near-Earth Object (NEO) threat. ESO was able to offer expert advice to the technical discussions and make constructive suggestions regarding ground-based observations as part of the proposals.

Elsewhere, ESO was represented in various network activities, including the Square Kilometre Array Founding Board, the OPTICON Board and Executive Committee, and the ASPERA Governing Board. In addition to its direct interaction with the European Commission, ESO

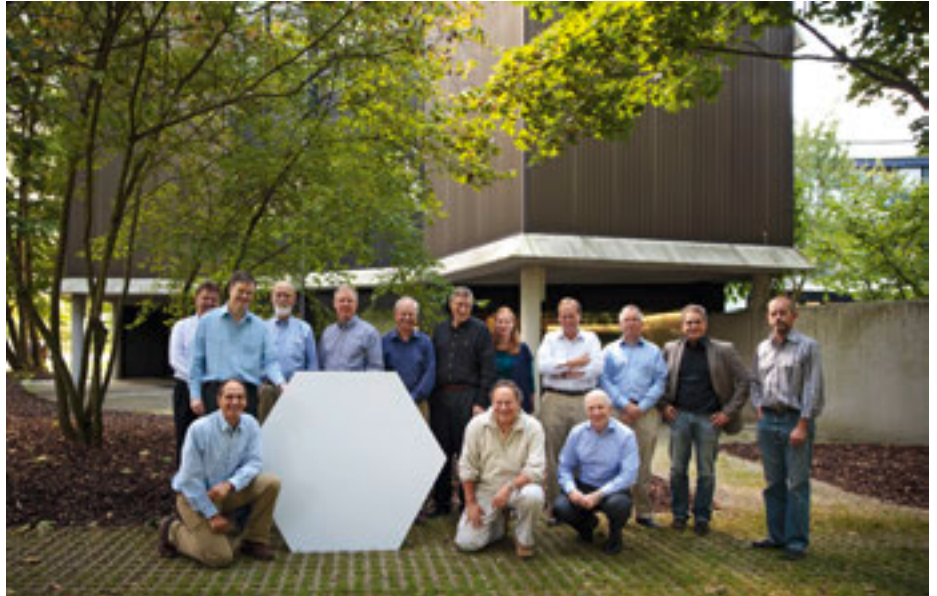

Participants in the European Extremely Large Telescope cost meeting, with a cardboard mock-up of an E-ELT mirror segment.

continued to maintain a variety of interactions with international organisations and activities across Europe, notably as a member of EIROforum, a partnership between eight of Europe's largest

intergovernmental scientific research organisations that are responsible for infrastructures and laboratories (CERN, EFDA-JET, EMBL, ESA, ESO, ESRF, European XFEL and ILL).



Participants in the EIROforum General Assembly 2012, held at the Institut Laue-Langevin (ILL) on 15–16 November 2012.

EIROforum

50th anniversary Gala event

The anniversary Gala event was held on Thursday, 11 October 2012, in the Kaisersaal of the Munich Residenz, seat of the former kings of Bavaria in the centre of Munich. The Residenz dates back to the beginning of the 16th century and the Kaisersaal was first built in the 17th century as a large entertainment room.

Eighteen months in the planning, the Gala was an impressive occasion that managed at the same time to capture the warmth and spirit of ESO, celebrating not only the history of the organisation, but also those who have contributed to its present success. The guests represented four decades of ESO history, including three former Directors General: Lo Woltjer

(1975–1987), Harry van der Laan (1988–1992) and Catherine Cesarsky (1999–2007) and current senior representatives from all the Member States, Brazil and Chile. Many former and present members of ESO committees also attended, together with prominent retired staff, former senior staff members and a selection of the current staff from Garching. ESO Fellows and Students, acting as guides, represented the current and future generations of astronomers.

The speakers were the President of the Council, Xavier Barcons; the German Minister for Education and Research, Dr Annette Schavan; the Bavarian State Minister for Science, Research and the Arts, Dr Wolfgang Heubisch; physics Nobel Laureate, Brian Schmidt; the current Director General, Tim de Zeeuw

and the Chilean Minister of Foreign Affairs, Alfredo Moreno Charme.

The Gala was a great success and provided a forum that showed ESO's successes to an audience that is not regularly exposed to ESO. A full report and the texts of the speeches were published in *The ESO Messenger's* 50th anniversary issue (No. 150, December 2012).

Photos from the ESO 50th anniversary Gala, held in the Residenz, Munich, on October 11, 2012. Top left: The Kaisersaal in the Munich Residenz, where the Gala took place. Top right: Tim de Zeeuw, ESO's Director General (centre), with ESO Students and Fellows. Bottom left: Prof. Lodewijk Woltjer, ESO Director General from 1975–1987, and Prof. Tim de Zeeuw. Bottom right: Prof. Brian Schmidt, Physics 2011 Nobel Laureate during his speech.







The oddly shaped Pencil Nebula (NGC 2736) is pictured in this image, produced by the Wide Field Imager on the MPG/ESO 2.2-metre telescope at ESO's La Silla Observatory in Chile. This nebula is a small part of a huge remnant left over after a supernova explosion that took place about 11 000 years ago.

Committees



ESD/C. Madsen



Council

As its governing body, the ESO Council determines the policy of the organisation with regard to scientific, technical and administrative matters while delegating the day-to-day running to the Director General (DG). Council and the DG are assisted by the following Committees:

The Finance Committee (FC) is charged with the general responsibility of advising Council on all matters of administrative and financial management, and making decisions, on behalf of Council, on matters for which they have been delegated the requisite powers, including the award of major contracts.

The Scientific Technical Committee is established as an advisory committee on matters related to the planning and operation of ESO and advises Council and the DG on policy matters of scientific importance and priorities.

The Users Committee (UC) is made up of representatives of ESO users from each Member State and advises the DG on matters concerning the use of ESO facilities (telescopes, instruments, computers, etc.).

The Observing Programmes Committee reviews and ranks all observing proposals and provides a recommendation to the DG for the distribution of observing time. The OPC is organised in topical panels by scientific categories.

The ALMA Proposal Review Committee (APRC) is made up of the APRC chair and the chairs of the ALMA Review Panels (ARP), of which there is at least one for each of the main scientific categories. APRC reviews the single ranked proposal list resulting from the merging of the individual ARP rankings and advises the ALMA Directors' Council on the scientific programme of ALMA.

Left: The underlying picture was taken at ESO's Garching Headquarters during the historic Council meeting of 11–12 June 2012 when the E-ELT programme was approved (subject to confirmation of the *ad referendum* votes). For a glimpse back in time, compare with the photo (top) of the Council in December 1987, when the VLT was approved.

Both the Council and the Committee of Council (the informal body of Council) normally meet twice during the year, 2012 being no exception. Although, unlike previous years, there was no specific requirement for any additional Extraordinary Council meetings, a number of very significant decisions were made during the 2012 meetings. Both Council meetings were held in Garching, on 11–12 June and 4–5 December. The first Committee of Council meeting was kindly hosted by the Czech delegation in Prague on 6–7 March while the second meeting returned to Garching on 10–11 October to coincide with the Gala event. All meetings were chaired by the President of Council, Prof. Xavier Barcons.

At the June meeting, an update was provided by the Council President and ESO Director General on a number of ongoing events/actions and the respective Directors/Division Heads presented feedback on all aspects of ESO's programme, including the status of La Silla, Paranal and ALMA. The status of the ratification process with Brazil was also highlighted, as well as progress made with regard to potential new Member States. The External Audit Report 2011 was approved by Council and discharge was granted to the Director General for the same year. In parallel, the mandate of the Portuguese Court of Auditors (Tribunal de Contas de Portugal) was extended for three years, covering the financial years 2012–14. A main focus for discussion was the European Extremely Large Telescope and how the programme would be taken forward.

As a consequence of these discussions, Council was able to make the important decision to approve, by simple majority, the principles regarding participation in the E-ELT supplementary programme and also approved — with a two-thirds majority of all Member States and pending confirmation of four *ad referendum* votes — the resolution concerning the approval of the construction of the E-ELT. This was indeed a most significant decision for ESO as an organisation, for the ESO Member States and for the world of astronomy. To end this extremely eventful meeting, a ceremony was held to mark the laying of the foundation stone for the new Headquarters extension building, to

Council and Committee of Council 2012

President	Xavier Barcons (Spain)
Austria	Sabine Schindler Daniel Weselka
Belgium	Christoffel Waelkens Sophie Pireaux
Czech Republic	Jan Palouš Jana Bystrická/Jan Buriánek
Denmark	Uffe Jørgensen Peter Sloth
Finland	Jari Kotilainen Pentti Pulkkinen
France	Jean-Marie Hameury Christophe Troyaux
Germany	Thomas Henning Thomas Roth
Italy	Bruno Marano Matteo Pardo
The Netherlands	Konrad Kuijken Jan van de Donk
Portugal	Teresa Lago Fernando Bello
Spain	Rafael Bachiller Luis E. Ruiz
Sweden	Claes Fransson David Edvardsson/Catarina Sahlberg
Switzerland	Georges Meylan Martin Steinacher (Vice President)
United Kingdom	Patrick Roche John Womersley

which local dignitaries as well as Council members were invited.

Following attendance at the Gala event in October 2012 to celebrate the 50th Anniversary of the founding of ESO, the delegates ended the year with the December Council meeting. As had been the case during the previous meeting, this resulted in further discussion about the E-ELT programme and its current status, with particular reference to the remaining

Member States who were not in a position to change their *ad referendum* vote. It was agreed that a working group would be established, dedicated to the development of the E-ELT. This working group will consist of Council delegates and members of the ESO Executive and will consider the potential options which are open to ESO, taking into account strategy, risks, etc. In addition to the discussions on the E-ELT, the budget for 2013 was approved. Elections took place

for appointments to the various ESO Committees including the ALMA Board, the European ALMA Science Advisory Committee (ESAC), FC, OPC, STC and the Tripartite Group, as well as the unanimous re-election of the Council President and Vice President, and the FC and STC Chairs. Council was also pleased to note the appointment of Dr Pierre Cox as the new ALMA Director.



The ESO Council at its meeting at ESO's headquarters in Garching, Germany on 4 December 2012. In the foreground on the left is the ESO Director General, Tim de Zeeuw and to the right the President of Council, Xavier Barcons.

Finance Committee

Finance Committee 2012

Chair	Johan Holmberg (Sweden)
Austria	Daniel Weselka
Belgium	Alain Heynen
Czech Republic	Věra Zázvorková
Denmark	Cecilie Tornøe (Vice-chair)
Finland	Sirpa Nummila
France	Patricia Laplaud
Germany	Gisela Schmitz-DuMont
Italy	Giampaolo Bologna
The Netherlands	Mirjam Lieshout-Vijverberg
Portugal	Fernando Bello (May)/ Maria José Almeida (November)
Spain	Inmaculada Figueroa
Sweden	Tobias Hellblom
Switzerland	Astrid Vassella
United Kingdom	Colin Vincent

The Finance Committee held two ordinary meetings, both chaired by Mr Johan Holmberg. It recommended the budget for the year 2013 for approval to Council. Furthermore, the delegates of the Member States who voted in favour of the E-ELT supplementary programme urged Council to approve the related contributions for the year 2013 as soon as the programme was confirmed. The Committee also dealt with further financial issues such as annual accounts, the external audit report, financial statements, Member States' contributions, and financial scenarios for the E-ELT. To secure ESO's cash position during the E-ELT's construction, an agreement between ESO and the European Investment Bank was supported.

A working group, established by the Committee the previous year, presented its results on how to find a new method for the calculation of the scale of Member States' contributions, with the purpose of decreasing the sometimes sharp variations. A final proposal will be available at the next meeting in May 2013.

The Committee approved the award of 16 contracts exceeding €500 000, seven single-source procurements exceeding €250 000 and five amendments to existing contracts. Out of these, nine contracts, two single-source procurements and one amendment were approved by written procedure. Also approved were the sale of a piece of ESO land in Antofagasta and an in-kind exchange for the European ALMA prototype antenna. The Committee welcomed the report on procurement statistics and industrial return coefficients.

The Finance Committee also discussed subjects concerning international and local staff as well as CERN Pension Fund matters.

ESO/C. Malin



Antennas of the Atacama Large Millimeter/submillimeter Array on the Chajnantor Plateau in the Chilean Andes.

Scientific Technical Committee

The Scientific Technical Committee 2012

Austria	Josef Hron (ESE)
Belgium	Hans Van Winckel (LSP)
Czech Republic	Michael Prouza (LSP)
Denmark	Johan Fynbo (LSP)
Finland	Lauri Haikala (ESAC)
France	Anne-Marie Lagrange (LSP)
Germany	Matthias Steinmetz
Italy	Alessandro Marconi (STC Chair)
The Netherlands	Marco de Vos (LSP Chair)
Portugal	Andre Moitinho (LSP)
Spain	Santiago Arribas Moco-roa
Sweden	Sofia Feltzing
Switzerland	Didier Queloz (LSP, ESE)
United Kingdom	Rob Ivison (ESAC Chair)
Chile	Leonardo Bronfman

Members at Large

Elaine Sadler (ESAC)
 Gillian Wright
 Rachel Akeson (ESAC)
 John Monnier (LSP)

Observer

Brazil Marcos Diaz

The STC had two regular meetings. The STC subcommittees met before the STC to discuss several of the topics in more detail, leading to recommendations by the STC itself.

78th STC meeting

The STC held its 78th meeting from 17–18 April in Garching. The La Silla Paranal Subcommittee (LSP) and the European ALMA Science Advisory Committee met on 16 April and reported the outcome of their deliberations to the STC. With the end of Phase B of the E-ELT, no further recommendations were required from the E-ELT Science and Engineering Committee (ESE), which stood down with effect from June 2012.

Eighteen out of 20 members, including the members at large from the USA and Australia, attended the meeting. In accordance with the Terms of Reference, S. Feltzing was nominated and unanimously accepted as STC Vice-chair. In order to finalise the composition of the subcommittees, the STC proposed to the Director General the appointment of Didier Queloz, Hans Van Winckel, and André Moitinho to the LSP and Rachel Akeson to ESAC.

The main topics of discussion were the White Paper on the Future of the La Silla-Paranal Observatory; VLT/I instrumentation planning; the science case for ERIS; and the Band 5 extension of ALMA.

The STC was presented with general options for the future of the LPO, in preparation for the submission of a White Paper to one of the next meetings. The Committee welcomed this evidence of ESO's preparations to operate the LPO in the E-ELT era and encouraged ESO to continue by exploring a broad range of possible strategies, together with the selection procedure for the associated new instrument capabilities, so as to better adapt to future scientific opportunities.

The STC reiterated its support for maintaining the LPO as a world-leading facility into the E-ELT era, with the continuing budget envisaged in the Long-term Perspectives document. The STC was pleased by the implementation of the fast data transfer (EVALSO infrastructure).

The STC considered the initial VLT/I instrumentation planning as a good starting point for development of a roadmap for a competitive LPO in the E-ELT era. The Committee believed that any instrumentation plan should arise naturally from the White Paper and the strategies chosen to operate the LPO. It encouraged ESO to continue to fully evaluate the impact of all projects on the whole programme.

A status report on the ERIS science case was presented to the STC for recommendation. The STC believed the science case to be extremely strong; the ERIS project offers the possibility of keeping

ESO/D. Munitz/VVV Team



This image from VISTA is a tiny part of the VISTA Variables in the *Via Lactea* survey that is systematically studying the central parts of the Milky Way in infrared light. On the right lies the globular star cluster UKS 1 and on the left lies a much less conspicuous new discovery, VVV CL001.

diffraction-limited imaging capabilities in modes or domains that will not be covered by SPHERE after NACO is decommissioned; and will allow the SPIFFI spectrometer to operate with the AOF. The STC met by teleconference following the Phase A review at the end of May and recommended construction.

The STC acknowledged the progress made on ALMA construction and was particularly excited by the spectacular first scientific results from Cycle 0. The Committee was pleased that the JAO and the ARCs were now sharing ALMA data processing and encouraged ESO to take all necessary steps to ensure completion of the ALMA CSV.

Recognising the importance of the science enabled with Band 5, the STC concurred with the cost cap and technical review requested by the ALMA Board and recommended that ESO conclude negotiations with the Band 5 consortium for the full production of the ALMA Band 5 cold cartridge assemblies.

The STC unanimously reaffirmed its extremely strong support for the E-ELT project. The Committee was very satisfied with the preparatory work conducted since its last meeting, but noted the high risk to European leadership in ground-based astronomy in the next decade that could arise from further delay in the start of the E-ELT programme.

79th STC meeting

The 79th meeting of the STC took place in Garching on 23–24 October. The LSP and the ESAC met the previous day, also in Garching, and duly reported to the STC. The main topics of discussion were the ESO Budget and Forward Look 2013–2016; updates on the E-ELT, ALMA and the LPO; and the presentation of the CUBES project.

The ESO Budget and Forward Look 2013–2016 was presented to the STC, which expressed its appreciation of the efforts made by ESO to maintain the LPO as the flagship for at least the next decade; and of the intention to maintain

the VLT/I technology upgrade project as the highest priority short-term project for Paranal. The Committee stressed the continuing need for strategic decisions to be taken in the context of a short-, medium- and long-term plan; reiterated that the necessary planning documents must therefore be available in good time for its next meeting; and offered to provide earlier feedback on draft documents if that would be helpful.

The STC congratulated Council on the provisional approval of the E-ELT project, praised ESO for the continuing activities in preparation of the construction phase, and welcomed the creation of the Project Science Team and the E-ELT Management Advisory Committee. The STC strongly favoured the establishment of a focussed subcommittee, reporting exclusively to the STC, to follow the development of the E-ELT project. This would provide the additional time and expertise that the STC considers essential to ensure full understanding of all aspects and consequences of the E-ELT programme.

The STC congratulated the ALMA operations and construction teams on the achievements of the past year and on the excellent scientific performance, the high quality of the papers emerging during the Early Science period and the obvious enthusiasm of the ever-widening user community. However, the STC was concerned about the low level of contingency remaining and the high level of staff turnover, with possible impact on the schedule and on the ALMA data archive, and urged ESO to address the issue.

The recovery activities carried out to address the NTT and UT4 failures and the exceptional effort and high commitment of the recovery teams were highly commended by the Committee, which was pleased to note that diagnostics were also prepared to minimise the risk of repetition. The STC also congratulated the KMOS team and ESO on the successful PAE and the impending commissioning.

Following the successful conclusion of Phase A, the committee proposed that

CUBES proceed to design and construction phases once Brazil has ratified its accession to ESO. In the meantime, the consortium and ESO should address the pending items, namely the broadening of the science case and the increase of ultraviolet expertise in the consortium.

The STC considered decisions like the 4-metre Multi-Object Spectroscopic Telescope (4MOST) down-selection process to be relevant for the future of LPO. The Committee would therefore have liked to have been informed with a document, which it considered should be issued by ESO not only for the benefit of the STC but also for the PIs of the multi-object spectrograph studies and the community at large.

Although welcoming the completion of most parts of the VISIR upgrade, the STC was very concerned by the reported system performance on sky and the possible consequences for the MATISSE and E-ELT-MIRI projects. It encouraged ESO to take advantage of the experience of the European Mid Infrared Imager (MIRI) team with this family of detectors, and supported ESO's intention to introduce more formal procedures for future instrument upgrades.

The Committee congratulated ESO and the VLT team on the progress made with VLT and PRIMA and on the significant increase in the number of science nights. In view of the likely delay to GRAVITY, the STC urged ESO to consider continuing support for PIONIER. The Committee looked forward to receiving results from ongoing tests and analyses and implementation plans for solutions at its next meeting.

The STC welcomed a possible call for public spectroscopic surveys with VIMOS, which it advised should be announced to the community with the deadline shifted by six months to allow the preparation of strong proposals. Although the imaging surveys are underway with increasing efficiency, ESO should make a clear statement on the next steps, taking account of the extended time to completion and the report from the Public Survey Panel.

Observing Programmes Committee

The Observing Programmes Committee 2012

Françoise Combes (Chair)
Dante Minniti (Vice-Chair P90)
Rolf Kudritzki (Vice-Chair P91)

Yann Alibert (P91)
Giuseppe Bono
Wolfgang Brandner (P91)
Andy Bunker (P90)
Matt Burleigh (P91)
Hugo Vicente Capelato (P90)
Romano Corradi
Ric Davies
Duncan Farrah (P91)
Laura Ferrarese (P90)
Francois Hammer (P91)
Guillaume Hebrard
Amina Helmi
Wolfgang Hillebrandt (P90)
Emmanuel Jehin (P90)
Jean-Paul Kneib (P91)
Norbert Langer
Seppo Mattila (P90)
Ronald Mennickent (P91)
Patrick Petitjean
Tom Ray
Sandra Savaglio (P90)
Daniel Schaerer
Rainer Schödel (P91)
Ian Smail (P90)
Linda Smith (P90)
Daniel Thomas

During its meetings from 21–25 May and from 19–22 November, the Observing Programmes Committee evaluated the proposals submitted for observations to be executed in Periods 90 (P90; 1 October 2012 to 31 March 2013) and 91 (P91; 1 April 2013 to 30 September 2013). The numbers of proposals for observation with the ESO telescopes in these two periods were 937 and 892 respectively. In addition, on account of the technical problems encountered during the re-commissioning of VISIR, a delta-call was issued in P91 for ISAAC and 153 proposals were received.

The distribution of proposals across the different scientific areas remained similar to recent periods. There were about twice as many proposals for Galactic scientific projects, pertaining to OPC categories C (interstellar medium, star formation and planetary systems) and D (stellar evolution), as for extragalactic topics, which comprise categories A (cosmology) and B (galaxies and galactic nuclei). The OPC categories are specified in full at www.eso.org/sci/observing/proposals/opc-categories.html

As in previous periods, FORS2 — which is mounted on Antu (Unit Telescope 1 of the VLT, or UT1) — was the VLT instrument on which the largest amount of observing time was requested (585 nights), ahead of X-shooter (402 nights) on Kueyen (UT2). Kueyen was again the most popular UT, with a ratio between the requested and the available time, or pressure, of 4.3, while the pressure on the other UTs was close to three. The possibility of installing a visitor instrument at the VLT Interferometer generated considerable interest in the community. Between P90 and P91, proposals requesting a total number of 105 VLTI nights were submitted for PIONIER, a near-infrared interferometric visitor instrument designed for imaging and fed by four telescope beams. These proposals were allocated 50 nights. The OPC reviewed 20 open-time proposals for the VISTA survey telescope, of which seven were scheduled.

On La Silla, HARPS and EFOSC2 remained in high demand. Within the framework of the continuing agreement between ESO and ESA for a joint tele-

scope time allocation scheme for coordinated observations with the VLT and XMM-Newton, proposals for such observations were invited again, for the ninth time, in 2012. ESO received two applications in P91, which qualified for allocation of telescope time. Time at both facilities was granted to two joint proposals evaluated by the XMM-Newton Observing Time Allocation Committee.

Targets of Opportunity

Despite the stricter criteria applied to Target of Opportunity (ToO) programmes since P86, the number of ToO proposals submitted in 2012 remained similar to previous years. For P90 and P91 respectively, the OPC evaluated 37 and 39 proposals, of which 22 and 21 were scheduled, for a total of about 470 hours. FORS2 is the most demanded instrument for ToO observations (about 300 requested hours), followed by X-shooter and UVES. These three instruments were allocated 74% of the ToO time.

Calibration Programmes

Calibration Programmes (CPs) allow users to complement the existing coverage of the calibration of ESO instruments. Their main evaluation criterion is the comparison of the potential enhancement of the outcome of future science that can be expected from their execution with the immediate return of current period science proposals directly competing for the same resources. A total of four CPs were submitted in 2012, two of which were recommended by the OPC for implementation.

Large Programmes

Large Programmes (LPs) are projects requiring a minimum of 100 hours of observing time that have the potential to lead to a major advance or breakthrough in the relevant field of study. LP execution is spread over several observing periods with a maximum duration of four years for observations to be carried out with the La Silla telescopes, and of two years on the VLT/I and on APEX. A total of 42 LP proposals were received in 2012:

22 in P90 and 20 in P91. Following the OPC recommendations, four new LPs were implemented in P90, and five in P91. The trend towards using a large fraction of the science time on the La Silla telescopes for the execution of LPs, encouraged by ESO and already embraced by the community in recent years, continued. Eight continuing LPs were scheduled on the 3.6-metre telescope in P90, receiving a total allocation of 122 nights (71% of the science time). At the NTT during the same period, six LPs were underway, totalling 101 nights of observing time (this includes the PESSTO Public Spectroscopic Survey, to which 90 nights per year are allocated).

Director's Discretionary Time

Proposals asking for Director's Discretionary Time (DDT) may be submitted throughout the year for programmes that present a level of urgency incompatible with the regular proposal cycles handled by the OPC. In 2012 the ESO user community submitted 89 DDT proposals. After taking advice from an internal committee comprising ESO staff astronomers, the Director General approved for implementation 49 DDT proposals. The total amount of allocated DDT time was about 180 hours.

The Wide Field Imager on the MPG/ESO 2.2-metre telescope at the La Silla Observatory has imaged a region of star formation called NGC 3324. The intense radiation from several of NGC 3324's massive, blue-white stars has carved out a cavity in the surrounding gas and dust.

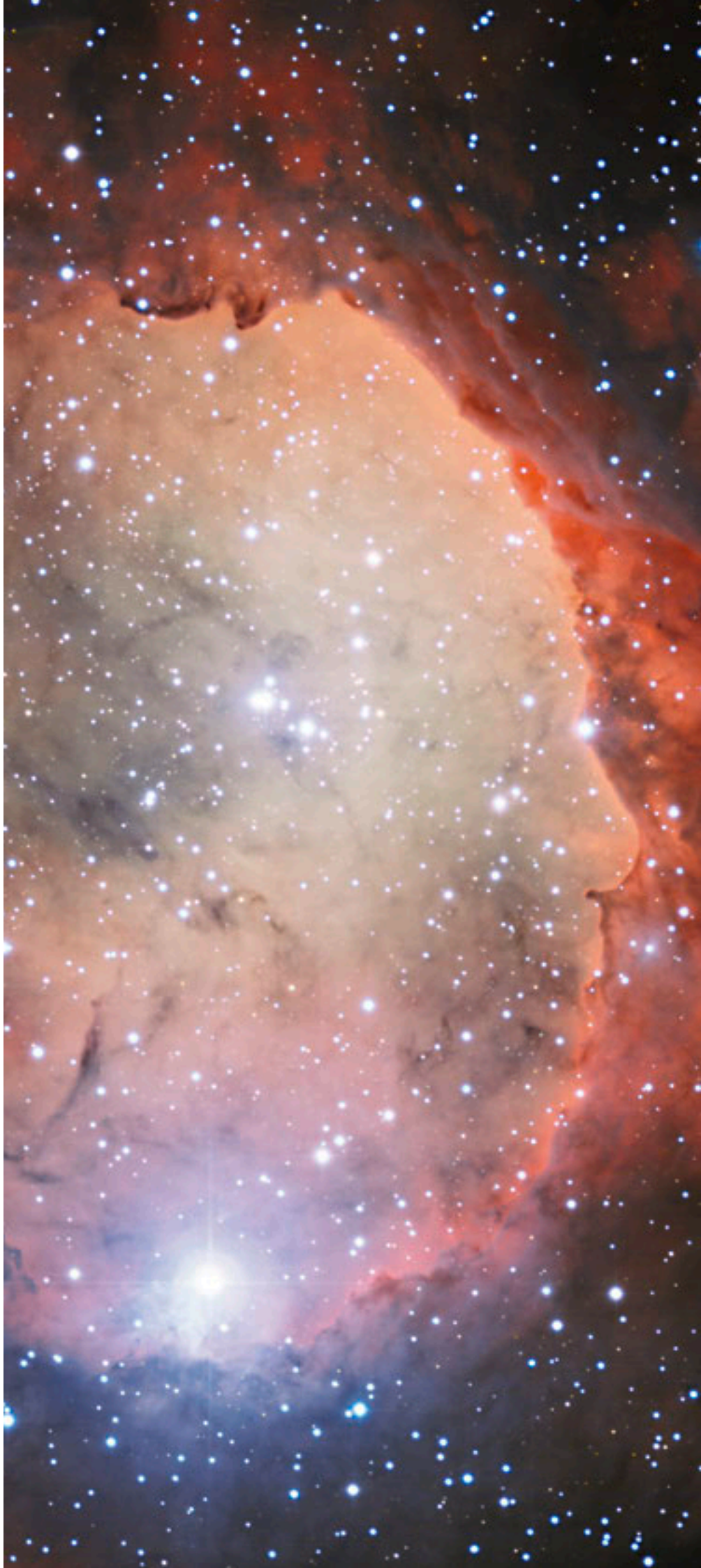

ALMA Proposal Review Committee

The ALMA Proposal Review Committee and its 11 ALMA Review Panels met in Santiago from 1–5 October to discuss the 1131 proposals submitted in response to the ALMA Early Science

Cycle 1 call for proposals. The APRC, chaired by Françoise Combes, ranked all proposals based on scientific merit. The ranked list of proposals was then split by regions and the highest priority

projects were chosen from the lists to fill the share of ALMA time for each partner. The final list of 192 highest priority projects includes 53 projects with Pls from the ESO Member States.

The ALMA Proposal Review Committee for Early Science Cycle 1

Françoise Combes (Chair)	Paris Observatory (France)
Susanne Aalto	Chalmers University of Technology (Sweden)
Rachel Akeson	California Institute of Technology (USA)
Hector Arce	Yale University (USA)
Andrew Baker	Rutgers, The State University of New Jersey (USA)
John Bally	University of Colorado at Boulder (USA)
Felipe Barrientos	Pontificia Universidad Católica de Chile (Chile)
Maite Beltran	Arcetri Astrophysical Observatory (Italy)
Jacqueline Bergeron	Institut d'Astrophysique de Paris (France)
Michael Bietenholz	York University (Canada)
Andrew Blain	University of Leicester (UK)
Dominique Bockelee-Morvan	Paris Observatory (France)
Leo Bronfman	Universidad de Chile (Chile)
John Carpenter	California Institute of Technology (USA)
Paola Caselli	The University of Leeds (UK)
Jose Cernicharo	Centro de astrobiología (INTA-CSIC) (Spain)
Claire Chandler	National Radio Astronomy Observatory, Socorro (USA)
Tracy Clarke	Naval Research Laboratory (USA)
Leen Decin	Catholic University of Leuven (Belgium)
Asuncion Fuente	National Astronomical Observatory (Spain)
Yasuo Fukui	Nagoya University (Japan)
Gaspar Galaz	Pontificia Universidad Católica de Chile (Chile)
Guido Garay	Universidad de Chile (Chile)
Maryvonne Gerin	Paris Observatory (France)
Mark Gurwell	Harvard-Smithsonian Center for Astrophysics (USA)
Jorma Harju	Helsinki University (Finland)
Naomi Hirano	Academia Sinica Institute of Astronomy and Astrophysics (Taiwan)
Leslie Hunt	Arcetri Astrophysical Observatory (Italy)
Frank Israel	Leiden Observatory (The Netherlands)
Rob Ivison	Royal Observatory, Edinburgh (UK)
Andres Jordan	Pontificia Universidad Católica de Chile (Chile)
Seiji Kameno	Kagoshima University (Japan)
Sheila Kannappan	University of North Carolina at Chapel Hill (USA)
Hiroshi Karoji	The University of Tokyo (Japan)
Jill Knapp	Princeton University (USA)
Kotaro Kohno	The University of Tokyo (Japan)
Nario Kuno	Nobeyama Radio Observatory, NAOJ (Japan)

Darek Lis	California Institute of Technology (USA)
Ute Lisenfeld	Granada University (Spain)
Leslie Looney	University of Illinois at Urbana-Champaign (USA)
Dieter Lutz	Max-Planck-Institute for Extraterrestrial Physics (Germany)
Satoki Matsushita	Academia Sinica Institute of Astronomy and Astrophysics (Taiwan)
Tom Millar	Queen's University Belfast (UK)
Akira Mizuno	Nagoya University (Japan)
Raffaella Morganti	Netherlands Institute for Radio Astronomy (ASTRON) (The Netherlands)
Frédérique Motte	CEA Saclay (France)
Neil Nagar	University of Concepción (Chile)
Fumitaka Nakamura	National Astronomical Observatory of Japan (Japan)
Hideko Nomura	Kyoto University (Japan)
Karin Oberg	Harvard-Smithsonian Center for Astrophysics (USA)
Nagayoshi Ohashi	Academia Sinica Institute of Astronomy and Astrophysics (Taiwan)
Tomoharu Oka	Keio University (Japan)
Sadanori Okamura	Hosei University (Japan)
Hans Olofsson	Chalmers University of Technology (Sweden)
Takashi Onaka	The University of Tokyo (Japan)
Olja Panić	University of Cambridge (UK)
Alexandra Pope	University of Massachusetts at Amherst (USA)
Thomas Puzia	Pontificia Universidad Católica de Chile (Chile)
Luis-Felipe Rodriguez	National Autonomous University of Mexico (Mexico)
Seiichi Sakamoto	Japan Aerospace Exploration Agency (Japan)
Dave Sanders	University of Hawaii at Manoa (USA)
Sho Sasaki	RISE Project, NAOJ (Japan)
Joachim Saur	University of Cologne (Germany)
Marc Sauvage	CEA Saclay (France)
Peter Schilke	University of Cologne (Germany)
Eva Schinnerer	Max-Planck-Institute for Astronomy (Germany)
Matthias Schreiber	University of Valparaiso (Chile)
Nick Scoville	California Institute of Technology (USA)
Debra Shepherd	National Radio Astronomy Observatory, Socorro (USA)
Lister Staveley-Smith	International Centre for Radio Astronomy Research (Australia)
Lisa Storrie-Lombardi	California Institute of Technology (USA)
Masato Tsuboi	Japan Aerospace Exploration Agency (Japan)
Jean Turner	University of California at Los Angeles (USA)
Liese van Zee	Indiana University (USA)
Dave Wilner	Harvard-Smithsonian Center for Astrophysics (USA)
Gillian Wilson	University of California at Riverside (USA)
Christine Wilson	McMaster University (Canada)
Lucy Ziurys	Steward Observatory, University of Arizona (USA)

Users Committee

The Users Committee 2012

Austria	Werner Zeilinger (Chairperson)
Belgium	Martin Groenewegen
Czech Republic	Adéla Kawka
Denmark	Frank Grundahl
Finland	Seppo Katajainen
France	Claire Moutou
Germany	Thomas Preibisch
Italy	Stefano Benetti
The Netherlands	Scott Trager (Vice-chair)
Portugal	Nanda Kumar
Spain	Lourdes Verdes- Montenegro
Sweden	Kirsten Kraiberg Knudsen
Switzerland	Hans Martin Schmid
United Kingdom	Gary Fuller
Chile	Manuela Zoccali

The ESO Users Committee acts as an advisory body to the ESO Director General, representing the communities of users from the ESO Member States and Chile. According to its terms of reference, approved by the ESO Council on 10 December 2010: “The UC shall advise the ESO Director General on matters pertaining to *i.* the performance of the La Silla Paranal Observatory and ALMA, *ii.* the scientific access, operations and data management facilities of ESO, *iii.* other services offered by ESO to its users’ community and directly related to the scientific output of the La Silla Paranal Observatory and ALMA”.

The 2012 UC annual meeting took place on 23 and 24 April. It was organised by the User Support Department, within the Directorate of Operations. The agenda, prepared by ESO in close consultation with the UC Chair, included a series of updates provided by ESO staff involved in operations, a report by the UC Chair that summarised the main issues the Committee had received from the user community and a special session, i.e. an in-depth review of a specific topic. The latter can be a specific operational mode, an instrument or a service. Whenever possible, a couple of expert users are invited to attend this session and share their experiences and views with the UC and ESO.

In 2012 the special topic was Public Survey Data Products. Because of the investment of telescope time and resources that ESO makes in supporting Public Surveys, and the recent successful launch of the Phase 3 interface (for both the upload by the Public Survey PIs and the subsequent retrieval by any user of advanced data products), ESO was very eager to obtain feedback from its user community on the usefulness and friendliness of its Phase 3 services. Although only a few users had already had some experience with the newly released data products (probably because of the short time that had elapsed since the first dataset was publicly released), the UC representatives engaged in a very constructive discussion with ESO. Different aspects were reviewed, from data homogeneity (among the different Public Surveys) to the details of the data products and the policies and procedures applicable to the data upload. A more detailed summary of the discussion can be found in the approved minutes of the meeting (available from <http://www.eso.org/public/about-eso/committees/uc/uc-36th.html>).

A mid-term telecon meeting took place in early November, during which ESO and the UC updated each other on operationally-related issues.

ESO/G. Lombardi (gphoto.it)

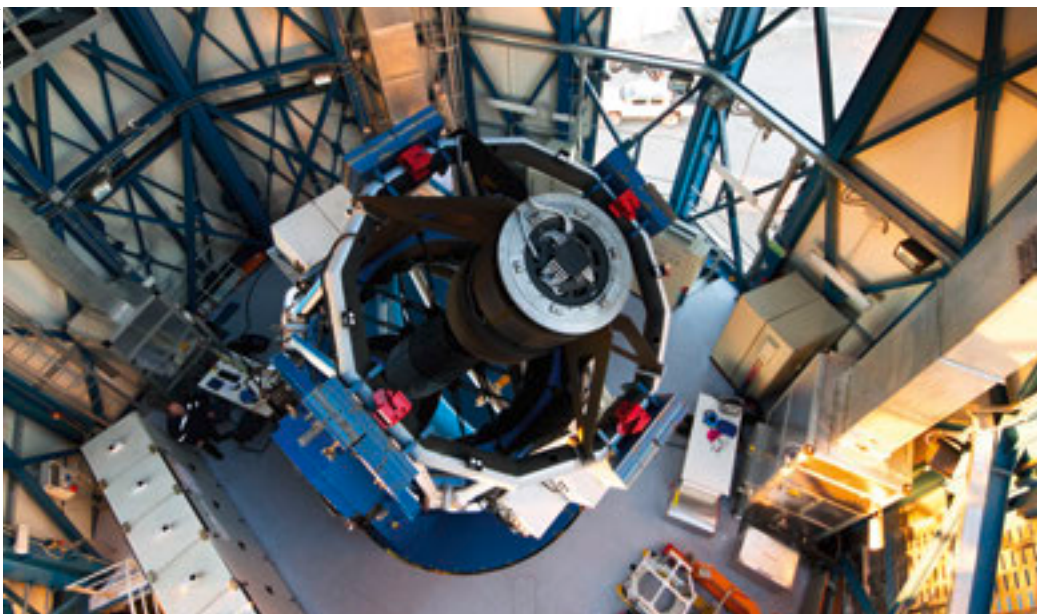

The VLT Survey Telescope at Cerro Paranal. The VST is a state-of-the-art 2.6-metre telescope equipped with OmegaCAM, a monster 268-megapixel CCD camera with a field of view four times the area of the full Moon.





This striking view of the central parts of the Milky Way was obtained with the VISTA survey telescope at ESO's Paranal Observatory in Chile. This huge picture is 108 500 by 81 500 pixels and contains nearly nine billion pixels. It was created by combining thousands of individual images from VISTA, taken through three different infrared filters, into a single monumental mosaic.

Outreach

ESO's 50th anniversary year was a prime opportunity to showcase ESO's frontline research, its innovative technology and the people behind the scenes. It was also the right time to reveal the innovative developments behind the E-ELT project. Several outreach efforts were carried out to extend coverage of the anniversary activities, including a widely distributed documentary about ESO which is attached to back cover of this Annual Report.

With the help of staff, outreach ambassadors, the ESO Science Outreach Network (ESON), volunteer translators, local venue organisers, and the beautiful products themselves, the public in the Member States and beyond were made aware of ESO's 50th anniversary, showing how the reality of a European dream has exceeded all expectations. This was also an opportunity to interest people in ESO's next 50 years, as ALMA approached completion and the E-ELT was about to start construction.

Communication channels were diversified further and new steps were taken towards better understanding the younger generation and the way they interact with the world, as part of the mission to make ESO a household brand. Co-creation became the buzzword for how to better engage with the public by letting them create — a trend that ESO is pioneering.

Press activities

ESO's education and Public Outreach Department published 53 press releases and 103 announcements during the year. The second most popular ESO release (see the top right figure) was the discovery of an Earth-mass planet around our neighbouring star Alpha Centauri B — and the nearest such planet to Earth (science release eso1241). It is also the lightest exoplanet ever discovered around a star like the Sun. The planet was detected using the HARPS instrument on the 3.6-metre telescope at La Silla.

The most popular release was photo release eso1242, which was the publication of a nine-gigapixel image (seen on the previous page) of the Galactic Bulge

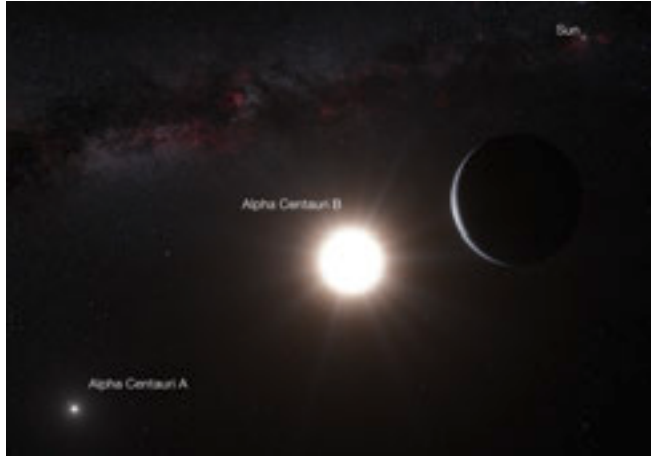

This photo-like artist's impression shows a planet orbiting the star Alpha Centauri B, a member of the triple star system that is the closest to Earth. Alpha Centauri B is the most brilliant object in the image and the other bright object is Alpha Centauri A. The Sun is visible as the bright star to the upper right. The tiny signature of the planet was found with the HARPS spectrograph on the 3.6-metre telescope at ESO's La Silla Observatory in Chile. This discovery led to one of the most popular press releases of the year.

obtained via the VVV survey using the VISTA telescope at Paranal. Using these data, a catalogue of more than 84 million stars in the central parts of the Milky Way was created. The image, which may be the largest astronomical panorama ever produced, gives viewers a spectacular, zoomable view of the central part of our galaxy (108 250 × 82 067 pixels, or 9 metres long and 7 metres tall if printed at book resolution). The success of the press release burdened our servers during the peak period, and to date about 700 000 web visitors have read this press

release alone — more than three times our previous record.

An ESO Picture of the Week was issued for each week of the entire year, providing both a series of beautiful and striking photographs and astronomical images, and a channel to report on news items that did not necessarily require a full press release or announcement. As part of ESO's 50th anniversary, a special set of *Then and Now* comparison Pictures of the Week, using historical and modern-day photographs, was issued once a

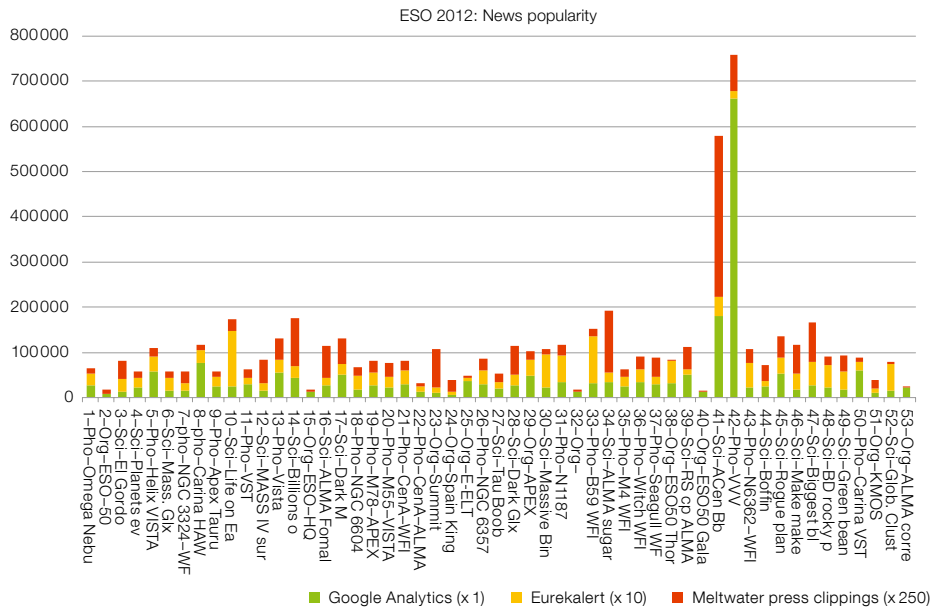

The relative popularity of the 53 press releases as measured by three different metrics (Google Analytics, EurekAlert and Meltwater). These three metrics have widely different values and have been scaled to the range of Google Analytics values. The most pop-

ular releases of the year overall were eso1241, reporting the discovery of a planet around the neighbouring star Cen B, and eso1242, which was the publication of a nine gigapixel image of the Galactic Bulge obtained via the VVV survey on VISTA.

month. These are seen on some of the pages of this Annual Report and show how things have changed over the decades at the ESO sites.

The production of astronomical images was maintained at the same level, with just over 100 images released, although the number of processed pixels doubled (due to the large VISTA VVV image). Thanks to the quality and volume of outreach images produced, combined with an aggressive promotion strategy, ESO has cemented its reputation as a recognised and respected source of top-quality astronomical images. This contributes strongly to both the popularisation of astronomy and to the establishment of ESO as a household brand for quality science outreach. A small fraction of the ESO images were derived from vintage, archival data, but most of the images are now coming from the new survey telescopes and the ongoing Cosmic Gems programme. This programme makes use of small amounts of telescope time for outreach images under weather and ambient conditions that are not suitable for science programmes.

ESO received more than 130 interview requests from the media in addition to interviews given during media visits to the sites. This led to a substantial number of articles in print, online and in the electronic media.

Publications

The number of products produced decreased from 99 in 2011 to 79 in 2012, but the number of pages produced increased by 68% to 3870. Fourteen were special products for ESO's 50th anniversary, among them the two major anniversary books *Europe to the Stars* and *The Jewel on the Mountaintop*.

Audiovisuals

The main audiovisual product this year was the 63-minute Blu-ray movie *Europe to the Stars — ESO's first 50 years of Exploring the Southern Sky*. Twelve episodes of the ESOcast video podcast and one video news release were published during the year. In addition, five

video compilations on topics related to ALMA, VLT and the E-ELT were released.

The number of images in the online image archive grew from 5042 to 6427 (up 27%). The number of videos in the online video archive grew from 1410 to 2002 (up 42%).

The recruitment of volunteer translators continued. They provide translations of, for instance, ESOcast subtitles in advance of the release of new episodes. This list of translators has been further developed as a network of volunteers for other translation needs. At the end of the year 636 subtitle translations were available online.

Exhibitions and events

The main focus for the exhibitions was the 50th anniversary. *Awesome Universe — the Cosmos through the eyes of the European Southern Observatory*, was a special exhibition campaign to mark the anniversary. It was presented internationally in cooperation with ESO's partners in Europe and around the world at more than 50 venues in about 20 countries, with an estimated attendance of at least 300 000–400 000. The exhibit consisted of a gallery of 50 visually stunning images, showcasing celestial objects such as galaxies, nebulae, and star clusters as seen by ESO's observatories, as well as beautiful images of the observatories themselves.

ESO's nine permanent exhibitions continued to draw crowds and additional

exhibits were arranged at 14 events in Europe and beyond, including the SPIE Astronomical Telescopes and Instrumentation conference, the European Week of Astronomy and Space Science EWASS 2012, and the International Astronomical Union XXVIII General Assembly. In many cases the exhibitions were carried out in partnership with local organisers to reduce the load on ESO's resources. In Chile 18 outreach events and exhibitions took place, including five 50th anniversary events. Eight other outreach events in Chile were supported, including the event involving the Nobel Laureate Brian Schmidt at the Chilean Senate in Santiago, with over 300 participants. By far, the largest event supported was the Summit of the Pacific Alliance (Paranal, 5–7 June).

A series of more than 50 specific anniversary events was arranged in approximately 20 countries, on or around the anniversary date of 5 October. ESO speakers and materials were provided, as well as a three-metre banner with the anniversary VST image of the Carina Nebula, which was unveiled exclusively at the events.

On 5 October, to mark the anniversary date itself, a six-hour live webcast "A Day in the Life of ESO" was broadcast, streaming live VLT observations from the Paranal control room and the mountaintop observing platform, public talks from the Garching headquarters, the *Europe to the Stars* movie, prize quizzes, and many popular question and answer sessions.

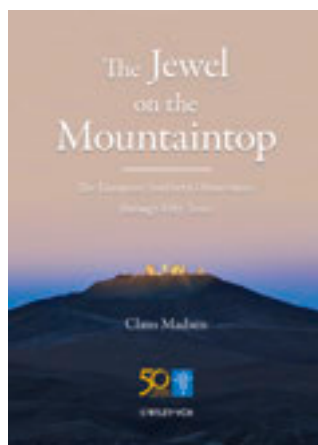



Web and software development

Many new features were rolled out across the main websites. The back-end infrastructure also received significant improvement, both on the system side, with the database servers upgraded to more modern devices with a streamlined configuration, as well as the integration servers upgraded to a new IT virtualised server farm.

The email newsletter infrastructure was also upgraded and consolidated. As an example, 24 different language versions of the newsletter, *ESO News*, are issued every week.

The ESO and Hubble Top 100 iPad apps have been upgraded to v2 with support for the new Retina displays. Between July and December, the apps were downloaded more than 129 000 times and 250 000 installations were upgraded from v1 to v2.

In spite of the fact that more than half of our audience targets are being reached via platforms other than the ESO website, the number of visits to the *eso.org* site increased by 15%, from 3.3 to 3.8 million. This is likely to be a result of the added visibility in the anniversary year.

Media, VIP and weekend visits in Chile

In collaboration with Representation and Operations in Chile, a total of 77 media and VIP visits to ESO sites were handled (19% fewer than in 2011), with the number of person-days spent at the sites at the same level as in 2011 (162 days). Among the visits was the IMAX film *Hidden Universe*, due to be launched in 2013, the planetarium show, *Water: A Cosmic Story*, and the Dutch TV programme *Labyrinth*.

Two media delegations of top science journalists from Brazil and Austria were invited through the ESON network and offered a special programme to visit the Paranal and ALMA Observatories.

Left: More than 100 anniversary events and exhibitions took place during the year. The collage gives an impression of the impressively broad landscape of the displays and the ways and means that were employed to attract the general public.

Web visitors 2012: 7 687 481

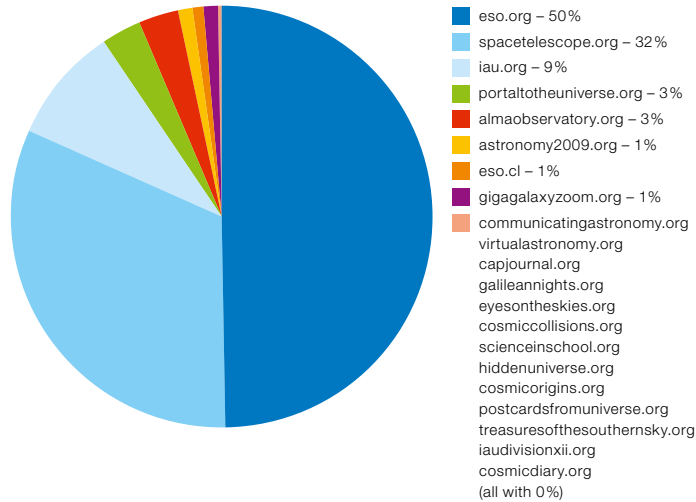

Distribution of the 7.7 million web visits among the ESO websites. While the overall number of visitors decreased by 7% from 2011, the number of visits to the main *eso.org* site increased by 15%, from 3.3 to 3.8 million.

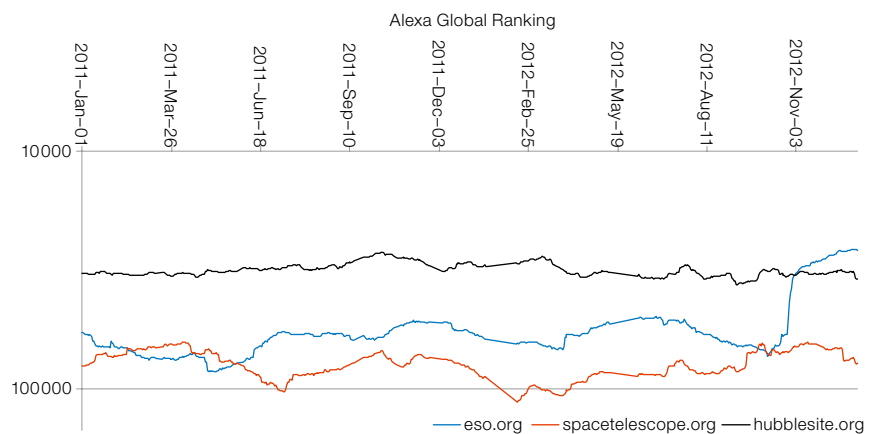

Through most of the year *eso.org* maintained its typical Alexa ranking as the 50 000th most popular site in the world, although during the fourth quarter it reached its highest ranking so far, as 26 000th most

popular site (for the first time above NASA's *hubblesite.org*, which is usually the most popular observatory-related website).



The picture shows President Fischer of Austria and his wife Margit Fischer looking at a gift from ESO's Representative in Chile, Massimo Tarenghi.

Several VIP visits were supported by ePOD, such as the visit of the President of Austria to the ESO office in Santiago and the visit to Paranal by the Federal Minister of Education and Research of Germany, Annette Schavan. The largest VIP visit supported was the IV Summit of the Pacific Alliance (5–7 June), where four heads of state (Chile, Peru, Colombia and Mexico) and some 80 delegates and government representatives (from Australia, Costa Rica, Panama, Canada and Japan) were present at Paranal for two days of high-level political discussions. The event was widely covered across South America, with over 100 journalists present on site. On the second day of the event, His Majesty the King of Spain also visited Paranal.

Public visits to the observatories went up 5% compared to 2011, with a total of 7896 weekend visitors at La Silla and Paranal.

ESO Science Outreach Network

The ESO Science Outreach Network continued to increase its strategic importance for ESO's visibility in the Member States and beyond. At the end of the year more than 15% of the pages on eso.org were read in languages other than English (see the figure above).

ESON added nodes in Russia, Romania and Latvia. Apart from the main website, ESO now has 31 national mini-sites, 28 of them with original content (plus three in English), covering 28 countries, in 19 different languages. Press releases are translated into 18 different languages. More than one and a half billion people can now, in principle, access information about ESO and instantly read about the recent astronomical discoveries in their native language. In addition a special "translation" for kids called Space Scoop was added in several languages in a fruitful collaboration with the European Universe Awareness programme.

Education

ESO continued to support *Science in School*, the European science education journal published by EIROforum, and pro-

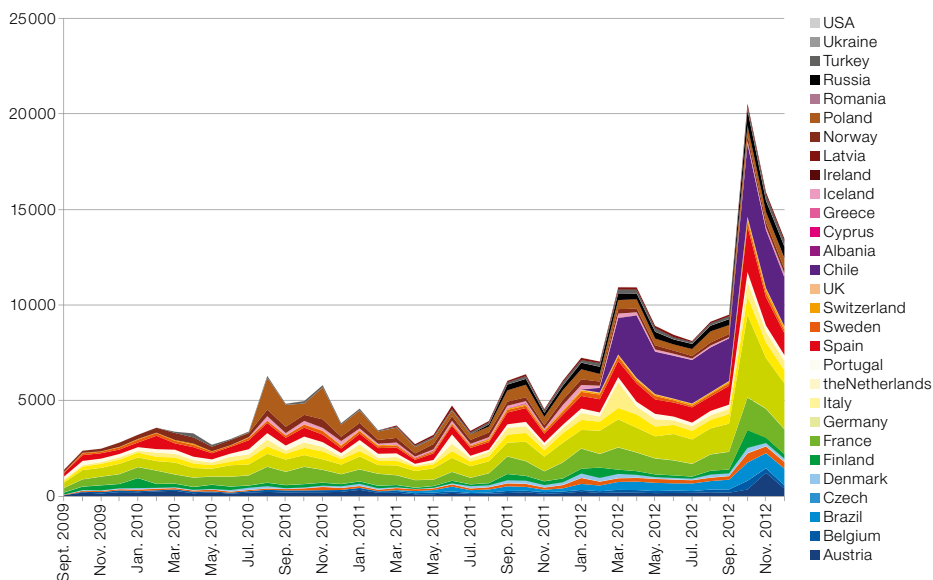

Translated web pages delivered by the ESO Science Outreach Network shown per country per month. The bluish colours identify the Member States, and reddish colours are used for the additional ESON

members; Chile is identified in purple. At the end of the year, over 15% of ESO's pages were delivered in languages other than English.

vided a trip to Paranal as one of the EIROforum special prizes for the European Union Contest for Young Scientists.

Community coordination and distribution

ESO's community coordination efforts focussed primarily on promoting ESO's 50th anniversary to as large an audience as possible, but also on improving and expanding our existing communication avenues.

A targeted distribution was implemented for the anniversary videos, merchandise, events etc. We engaged with our online communities via two anniversary competitions and created buzz around the live streaming anniversary event. Special attention was given to generating book reviews and distributing the anniversary documentary to planetariums, public observatories, and TV producers.

Our distribution infrastructure was improved by consolidating the address database and adding new stakeholders such as former ESO Fellows and Students, former ESO staff and IT media. At the same time, our newsletter subscriber base grew to more than 20 000 people.

Our reach was expanded through partnerships with top education app developers, IMAX producers, live blogs, special media, and our network of ambassadors was also expanded significantly.

Both on Facebook and Twitter, the size of ESO's communities increased substantially — the number of Twitter followers almost doubled (up 93% to 12 486) and the Facebook fans went up by 58% (to 28 260) — both with a clear bump in the numbers in the fourth quarter due to the anniversary.

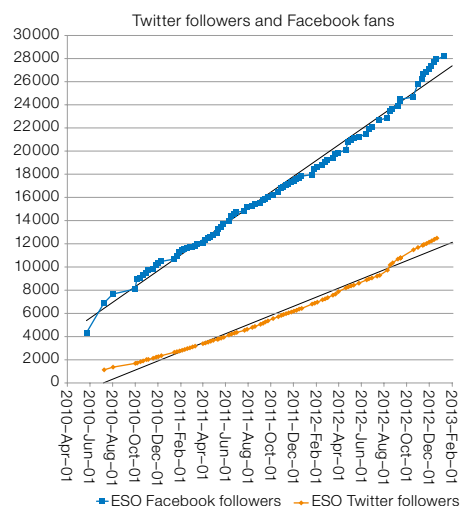



Striking image of NGC 6559, an object that showcases the anarchy that reigns when stars form inside an interstellar cloud. Taken by the Danish 1.54-metre telescope located at ESO's La Silla Observatory in Chile.

Calendar of Events

January

Exhibition: *Stargazing*, Oxford, UK.

Start of construction of the Headquarters extension building in Garching.

February

APEX Board meeting.

Joint ESO/IAG/USP Workshop on Circumstellar Dynamics at High Resolution, Foz do Iguaçu, Brazil, 27 February–2 March.

Exhibition: *ASTROFEST*, London, UK.

March

80th Committee of Council meeting.

Workshop on Observing Planetary Systems II, Santiago, Chile, 5–8 March.

ESO Overview (internal review).

April

ALMA Board meeting.

78th Scientific Technical Committee meeting.

Users Committee meeting.

The last official release of MIDAS was announced to the user community, concluding the development of the Munich Image Data Analysis System that has continued for more than 30 years.

Exhibition: *Torun Festival of Science and Culture*, Toruń, Poland.

Exhibition: *San Pedro de Atacama Astronomy Festival*, San Pedro de Atacama, Chile.

Exhibition: *Lange Nacht der Forschung*, Vienna, Austria.

May

133rd Finance Committee meeting. The meeting resulted in the approval of the first E-ELT construction project contract.

7th Conference on Astronomical Data Analysis (co-sponsored by ESO), Cargèse, Corsica, 14–18 May.

Observing Programmes Committee meeting.

The ratification of the Brazilian Accession Agreement came closer when the responsible ministries submitted the ESO file to the Casa Civil on 30 May.

June

125th Council meeting.

Summit of the newly created Pacific Alliance, attended by the Presidents of Chile, Colombia, Mexico and Peru (with a brief appearance by the King of Spain) took place on Paranal.

Foundation stone ceremony for the ESO Headquarters extension building.

July

ALMA exhibit at Royal Society Summer Science Exhibition. London, UK.

Exhibition: *EWASS2012*, Rome, Italy.

Exhibition: *SPIE Astronomical Telescopes and Instrumentation*, Amsterdam, Netherlands.

Conference: *30 years of Italian participation to ESO*, Rome, 2–3 July.

All scientific data from ESO's observatories in Chile are now transferred to the ESO Science Archive Facility in Garching via a high-speed internet connection.

August

Exhibition at the IAU XXVIII General Assembly, Beijing, China.

September

Conference: *ESO@50 – the first 50 years of ESO*, Garching, 3–7 September.

Annette Schavan, the Federal Minister for Education and Research in Germany, visited the Paranal Observatory on 29–30 September.

Publication of the 50th anniversary history book, *The Jewel on the Mountaintop – The European Southern Observatory through Fifty Years*.

Publication of the 50th anniversary coffee-table book *Europe to the Stars*.

October

81st Committee of Council meeting.

The 50th anniversary Gala event was held on Thursday, 11 October, in the Kaisersaal of the Munich Residenz.

APEX Board meeting.

Conference: *Science from the Next Generation Imaging and Spectroscopic Surveys*, ESO, Garching, 15–18 October.

79th Scientific Technical Committee meeting.

A very well-attended two-day presentation to potential contractors for the E-ELT dome and main structure was held at the Allianz Arena in Munich.

Exhibition: *Festival della Scienza: Imagination*. Genoa, Italy.

November

134th Finance Committee meeting.

ESO Workshop on Ecology of Blue Straggler Stars, Santiago, Chile, 5–9 November.

ALMA Board meeting.

Observing Programmes Committee meeting.

First light on-sky was achieved with the ESO second generation instrument KMOS on 21 November when a single star was acquired within the field of view of one of the 24 integral field units.

Exhibition: *Rencontres du Ciel et de l'Espace – 2012*, Paris, France.

December

VST inauguration.

126th Council meeting. This included the confirmation of the approval of the E-ELT project.

Conference: *The First Year of ALMA Science*, Puerto Varas, Chile, 12–15 December.

Visit of the President of Austria, Heinz Fischer and delegation to Vitacura.

The ALMA Back End Integrated Project Team at ESO was closed on 31 December on completion of its tasks.



This photograph captures one of the Unit Telescopes from the ESO Very Large Telescope against the twilight, on Cerro Paranal.

Glossary of Acronyms

4LGSF	Four-Laser Guide Star Facility	DFI	Data Flow Infrastructure (DFI) Department	GALACSI	Ground Atmospheric Layer Adaptive Optics for Spectroscopic Imaging (AOF)
4MOST	4-metre Multi-Object Spectroscopic Telescope (Proposed new spectroscopic instrument for VISTA or NTT)	DFOSC	Danish Faint Object Spectrograph and Camera	GHz	GigaHertz
A&A	Journal, <i>Astronomy & Astrophysics</i>	DG	Director General	GOODS	Great Observatories Origins Deep Survey
A&ARV	Journal, <i>Annual Review of Astronomy and Astrophysics</i>	DMO	Data Management and Operations Division	GRAAL	GRound-layer Adaptive optics Assisted by Lasers (AOF)
ADA	Astronomical Data Analysis	DTS	Department of Technical Services	GRAVITY	AO assisted, two-object, multiple-beam-combiner (VLT)
ADC	Analogue-to-Digital converter (ALMA)	EASC	European ALMA Support Centre	GRB	Gamma-ray Burst
AEM	ALMA European Consortium	EC	European Commission	GROND	Gamma-Ray Burst Optical/Near-Infrared Detector (2.2-metre)
AGB	Asymptotic Giant Branch	E-ELT	European Extremely Large Telescope	HARPS	High Accuracy Radial Velocity Planetary Searcher (3.6-metre)
AGN	Active Galactic Nucleus	EFDA-JET	European Fusion Development Agreement	HAWK-I	High Acuity Wide field K-band Imager (VLT)
AIV	Assembly, Integration and Verification	EFOSC2	ESO Faint Object Spectrograph and Camera (v.2)	HR	Human Resources
AJ	<i>The Astronomical Journal</i>	EIROforum	Organisation consisting of the seven largest scientific European international organisations devoted to fostering mutual activities	HRAG	Human Resources Advisory Group (ALMA)
ALMA	Atacama Large Millimeter/submillimeter Array	EM&P	Journal, <i>Earth, Moon, and Planets</i>	HST	Hubble Space Telescope
AMBER	Astronomical Multi-BEam combiner (VLT Instrument)	EMBL	European Molecular Biology Laboratory	Icar	Icarus, Planetary science journal
AN	Journal, <i>Astronomische Nachrichten</i>	ePOD	education and Public Outreach Department	ICT	Integrated Computing Team (ALMA)
Antu	VLT Unit Telescope 1	ERA-Net	European Research Area Net	ICT-EU	European ICT (ALMA)
AO	Adaptive Optics	ERIS	Enhanced Resolution Imaging Spectrograph	IF	Intermediate Frequency
AOF	Adaptive Optics Facility	ERP	Enterprise Resource Planning (Administration software)	IFU	Integral Field Unit
AOS	Array Operations Site (ALMA)	ESA	European Space Agency	ILL	Institut Laue-Langevin
APEX	Atacama Pathfinder Experiment	ESAC	European ALMA Science Advisory Committee	IMPRS	International Max Planck Research School
ApJ	<i>Astrophysical Journal</i>	ESE	E-ELT Science and Engineering Committee	IPAG	Institut de Planetologie et d'Astrophysique de Grenoble
ApJS	Journal, <i>Astrophysical Journal Supplement Series</i>	ESO	European Organisation for Astronomical Research in the Southern Hemisphere (European Southern Observatory)	IPSAS	International Public Sector Accounting Standards
APRC	ALMA Proposal Review Committee	ESON	ESO Science Outreach Network	IPT	Integrated Product Team (ALMA)
AQUARIUS	Mid-infrared detector array (VISIR)	ESPRESSO	Echelle SPectrograph for Rocky Exoplanet- and Stable Spectroscopic Observations	IRAM	Institut de Radioastronomie Millimétrique
ARA&A	Journal, <i>Annual Review of Astronomy and Astrophysics</i>	ESRF	European Synchrotron Radiation Facility	ISAAC	Infrared Spectrometer And Array Camera (VLT)
ARC	ALMA Regional Centre	ESTAC	ESO Standard Telescope Axis Controller	IT	Information Technology
ARP	ALMA Review Panel	EU	European Union	JAO	Joint ALMA Observatory
ASAC	ALMA Science Advisory Committee	EUROPEAN XFEL	European X-ray Free-Electron Laser	JIRA	Proprietary issue tracking product
ASIAA	East Asia FEIC (ALMA)	EVALSO	Enabling Virtual Access to Latin-american Southern Observatories	JPL	Jet Propulsion Laboratory
ASPERA	AstroParticle ERAnet	EWASS	European Week of Astronomy and Space Science	Jy	Jansky
ASSIST	Adaptive Secondary Setup and Instrument Simulator (AOF test bench)	ExA	Journal, <i>Experimental Astronomy</i>	KMOS	K-band Multi-Object Spectrograph (VLT)
ASTRONET	Astronomy ERA-NET	FC	Finance Committee	kpc	kiloparsec
AT	Auxiliary Telescope for the VLT	FE	Front End (ALMA)	Kueyen	VLT Unit Telescope 2
UK ATC	UK Astronomy Technology Centre	FE IPT	Front End Integrated Project Team (ALMA)	LABOCA	Large APEX Bolometer CAmera
BE	Back End (ALMA)	FEIC	Front End Integration Centres (ALMA)	LBG	Lyman-Break Galaxies
CAD	Computer Aided Design	FEROS	Fibre-fed, Extended Range, Échelle Spectrograph (2.2-metre)	LESS	LABOCA Extended Chandra Deep Field South Submillimetre Survey
CASA	ALMA data reduction software	FLAMES	Fibre Large Array Multi Element Spectrograph (VLT)	LFC	Laser Frequency Comb
CCD	Charge Coupled Device	FORS1	FOcal Reducer/low dispersion Spectrograph (VLT)-1	LGRB	Long-duration Gamma-ray Bursts
CE	Common Envelope	FORS2	FOcal Reducer/low dispersion Spectrograph (VLT)-2	LGSF	Laser Guide Star Facility
CERN	European Organization for Nuclear Research	FP	Fabry-Perot	LMC	Large Magellanic Cloud
CIS	Control and Instrument Software Department	FPGA	Field Programmable Gate Array	LP	Large Programme
CONDOR	1.5 THz heterodyne receiver (APEX)	FPn	nth EU Framework Programme	LPG	Liquefied Petroleum Gas
CONICA	COudé Near-Infrared CAmera (VLT)			LPO	La Silla Paranal Observatory
CONICYT	Comisión Nacional de Investigación Científica y Tecnológica (Chilean National Commission for Scientific and Technological Investigations)			LS	Legal Service
CP	Calibration Programme			LSP	La Silla Paranal
CRIRES	Cryogenic InfraRed Echelle Spectrometer (VLT)			LSP	La Silla Paranal Subcommittee
CSV	Commissioning and Science Verification			MARCUS	Mobility for ARC Users
CUBES	Cassegrain U-band Brazilian ESO Spectrograph			MASSIV	Mass Assembly Survey with SINFONI in VVDS
DDS	Data Distribution Service			MATISSE	Multi AperTure mid-Infrared Spectro-Scopic Experiment (VLT)
DDT	Director's Discretionary Time			Melipal	VLT Unit Telescope 3
				MIDAS	Munich Image Data Analysis System

MIDI	Mid-infrared Interferometric Instrument (VLT)	Pn	Period #n	ToO	Target of Opportunity
MIRI	Mid-infrared Instrument (E-ELT)	PRC	Program Review Committee (ALMA)	TRAPPIST	TRAnsiting Planets and Planetesimals Small Telescope
mmVLBI	Millimetre VLBI	PRIMA	Phase-Referenced Imaging and Micro-arcsecond Astrometry facility (VLT)	UC	Users Committee
Mn	Mirror #n			UCN	Católica del Norte University (Universidad Católica del Norte)
MNRAS	Journal, <i>Monthly Notices of the Royal Astronomical Society</i>	PROP	Portal for Reporting of Operational Problematics	UK	United Kingdom
MPE	Max Planck Institute for Extraterrestrial Physics (Das Max-Planck-Institut für extraterrestrische Physik)	PST	Project Science Team	ULTRACAM	Ultrafast Camera (VLT)
		QSO	Quasi Stellar Object, quasar	UltraVISTA	Ultra-deep near-infrared survey in the COSMOS field
MPG	Max Planck Society (Max-Planck-Gesellschaft)	RadioNet	Radio Astronomy Network in Europe	UPS	Uninterruptible Power Supplies
		RAL	Rutherford Appleton Laboratory, Didcot (UK)	USA	United States of America
MPiFR	Max Planck Institute for Radio Astronomy (Max-Planck-Institut für Radioastronomie)	RAMS	Reliability, Availability, Maintainability and Safety	USD	User Support Department
		Reflex	Software platform running ESO data reduction modules	UT	Unit Telescope of the VLT
MUSE	Multi Unit Spectroscopic Explorer (VLT)	RMS	Root Mean Square	UT1–4	VLT Unit Telescopes 1–4: Antu, Kueyen, Melipal and Yepun
		RNA	Ribonucleic acid	UVES	UV-Visual Echelle Spectrograph (VLT)
MUX	Multiplexers	SABOCA	Shortwave Apex Bolometer Camera	VCM	Version Control Management
NACO	NAOS-CONICA (VLT)	SAPHIRA	Detector for the GRAVITY wavefront sensor	VHS	VISTA Hemisphere Survey
NAOJ	National Astronomical Observatory of Japan			VIDEO	VISTA Deep Extragalactic Observations Survey
NAOMI	Adaptive optics system for the ATs (VLT)	SAXO	SPHERE's AO system (VLT)	VIKING	VISTA Kilo-degree Infrared Galaxy survey
		SciOps2.2	Revised Science Operations plan (Paranal)		Visible MultiObject Spectrograph (VLT)
NAOS	Nasmyth Adaptive Optics System (VLT)	SCO	Santiago Central Office (ALMA/ESO Vitacura)	VIMOS	VISTA IR Camera
NASA	National Aeronautics and Space Administration	SDD	Software Development Division	VIRCAM	VLT Imager and Spectrometer for mid-InfraRed
		SDSS	Sloan Digital Sky Survey	VISIR	Visible and Infrared Survey Telescope for Astronomy
NEO	Near-Earth Object	SE	System Engineering (ALMA)	VISTA	Very Long Baseline Interferometry
NewA	Journal, <i>New Astronomy</i>	SED	Software Engineering Department	VLBI	Very Large Telescope
NewAR	Journal, <i>New Astronomy Reviews</i>	SHFI	Swedish Heterodyne Facility Instrument (APEX)	VLT	Very Large Telescope Interferometer
NOVA	The Netherlands Research School for Astronomy (Nederlandse Onderzoekschool voor Astronomie)	SINFONI	Spectrograph for INtegral Field Observations in the Near Infrared (VLT)	VLTSW	VLT software
				VM	Visitor Mode
NRAO	National Radio Astronomy Observatory			VMC	VISTA survey of the Magellanic Cloud system
NTT	New Technology Telescope	SLODAR	Slope Detection and Ranging Technique	VME	Virtual Machine Environment
OB	Observation Block	SM	Service Mode	vOT	Visitor Mode Observing Tool
OCA	Cote d'Azur Observatory (Observatoire de la Cote d'Azur)	SMC	Small Magellanic Cloud	VPHA+	VST Photometric H α Survey (incorporating UVEX south)
OEM	Original Equipment Manufacturers	SMG	Submillimetre Galaxies	VST	VLT Survey Telescope
OmegaCAM	Optical Camera for the VST	SOCHIAS	Chilean Astronomical Society (Sociedad Chilena de Astronomía)	VVDS	VIMOS VLT Deep Survey
OPC	Observing Programmes Committee			VVV	ESO Public Survey VISTA Variables in the Vía Láctea
OPTICON	Optical Infrared Coordination Network for Astronomy	SOFI	SOn oF Isaac (NTT)	WDM	Wavelength Division Multiplexing
		SPARTA	Standard Platform for Adaptive optics Real Time Applications	WFI	Wide Field Imager (2.2-metre)
OSF	ALMA Operations Support Facilities			WFS	Wavefront Sensor
OSO	Onsala Space Observatory	SPHERE	Spectro-Polarimetric High-contrast Exoplanet Research instrument (VLT)	WIMP	Weakly Interacting Massive Particle (dark matter candidate)
OT	Observing Tool			WS	Workstation
P&SS	Journal, <i>Planetary and Space Science</i>	SPIE	Society of Photo-optical Instrumentation Engineers	XMM-Newton	X-ray Multi-Mirror satellite (ESA)
				X-shooter	Wideband ultraviolet-infrared single target spectrograph (VLT)
P2PP	Phase 2 Proposal Preparation	SPIFFI	SPectrometer for Infrared Faint Field Imaging	Yepun	VLT Unit Telescope 4
PA	Product Assurance			zCOSMOS	Large Programme to measure 30 000 galaxies in the HST Cosmic Origins field
PAE	Provisional Acceptance Europe	SSFR	Specific Star Formation Rate	Z-Spec	Millimetre-wave spectrograph (APEX visitor instrument)
PARLA	PARanal Raman Laser (VLT)	STC	Scientific Technical Committee	Λ	Cosmological constant
PARSEC	Sodium line laser for VLT AO	STFC	Science and Technology Facilities Council (UK)	Λ CDM	Lambda Cold Dark Matter
P-Artemis	Prototype large bolometer array (APEX)				
PASJ	Journal, <i>Publications of the Astronomical Society of Japan</i>	SV	Science Verification		
		SW	Software		
PASP	Journal, <i>Publications of the Astronomical Society of the Pacific</i>	TAROT	Télescopes à Action Rapide pour les Objets Transitoires		
PESSTO	Public ESO Spectroscopic Survey of Transient Objects	TB	Terabyte		
		TCE	Control Engineering Department		
PI	Principal Investigator	TEC	Technology Division		
PIONIER	Precision Integrated-Optics Near-infrared Imaging Experiment (VLT visitor instrument)	TEE	Telescope Electronic Engineering		
		telbib	ESO library telescope bibliography database		
PLC	Programmable Logic Controllers (E-ELT)	THz	Terahertz		
		TNO	Netherlands Organisation for Applied Scientific Research (Nederlandse Organisatie voor Toegepast Natuurwetenschappelijk Onderzoek)		

ESO Europe

Headquarters
Karl-Schwarzschild-Str. 2
85748 Garching bei München
Germany
Phone +49 89 320 060
Fax +49 89 320 2362
Email: information@eso.org
www.eso.org

ESO Chile

Santiago Office
Alonso de Córdova 3107
Vitacura
Casilla 19001
Santiago de Chile
Chile
Phone +56 2 2463 3000
Fax +56 2 2463 3101

La Silla Paranal Observatory
La Silla Site
IV Región
Chile
Phone +56 2 2464 4100
Fax +56 2 2464 4101

La Silla Paranal Observatory
Paranal Site
II Región
Chile
Phone +56 55 2435 100
Fax +56 55 2435 101

APEX Sequitor Base
Ayllo de Sequitor, Parcela 85
San Pedro de Atacama
II Región
Chile
Phone +56 55 448 200
Fax +56 55 448 221

APEX Chajnantor Site
II Región
Chile
Phone +56 55 448 299

La Serena Office
Avenida Panorámica 4461
Sector Aeroparque La Florida
Casilla 567
La Serena
Chile
Phone +56 51 272 601
Fax +56 51 215 175

Guesthouse
Rey Gustavo Adolfo 4634
Las Condes
Santiago
Chile
Phone +56 2 2208 4254
Fax +56 2 2228 9333

Antofagasta Office
Avenida Balmaceda 2536
Office 504
Edificio 'Don Guillermo'
Antofagasta
Chile
Phone +56 55 260 032
Fax +56 55 260 081

ESO is a partner in the international ALMA project

ALMA Santiago Central Offices
Alonso de Córdova 3107
Vitacura
Casilla 763 0355
Santiago
Chile
Phone +56 2 2467 6100
Fax +56 2 2467 6101

ALMA Operations Support Facility
Kilómetro 121
Carretera CH 23
San Pedro de Atacama
Chile
Phone +56 55 448 416
Fax +56 55 448 481

ALMA Array Operations Site
II Región
Chile

Cover: The spectacular star-forming Carina Nebula has been captured in great detail by the VLT Survey Telescope at ESO's Paranal Observatory. This picture was taken with the help of Sebastián Piñera, President of Chile, during his visit to the observatory on 5 June 2012 and released on the occasion of the new telescope's inauguration in Naples on 6 December 2012.

Credit: ESO

Acknowledgement: VPHAS+ Consortium/Cambridge Astronomical Survey Unit

Inside back cover: DVD with the 63-minute documentary movie Europe to the Stars — ESO's first 50 years of Exploring the Southern Sky. Subtitles in 20 languages are available: Česky, Dansk, Deutsch, English, Ελληνικά, Español, Français, íslenska, Italiano, Nederlands, Polski, Português, Português (Brasil), Русский, Română, Slovenski, Suomen, Türkçe, Українська, हिन्दी.

All images are courtesy of ESO unless otherwise indicated.

Edited by the Science Directorate

Produced by the education and Public Outreach Department

ESO 2013
ISSN 0531-4496

